

VIP Parts



VERSÃO 2026-0

SUMÁRIO

Flexíveis.....	3
Ponteiras.....	15
Ponteiras VIP.....	20
Abafadores.....	22
Curvas.....	24
Tubos.....	27
Abraçadeiras.....	28
Pesos.....	31
Tubos Coletores.....	35
Silenciosos Universal.....	39
Silencioso Alta Performance.....	40
Catalisadores.....	41
Coletor.....	45
Acessórios.....	48
V-Band.....	52
Difusores.....	54
Apito.....	56

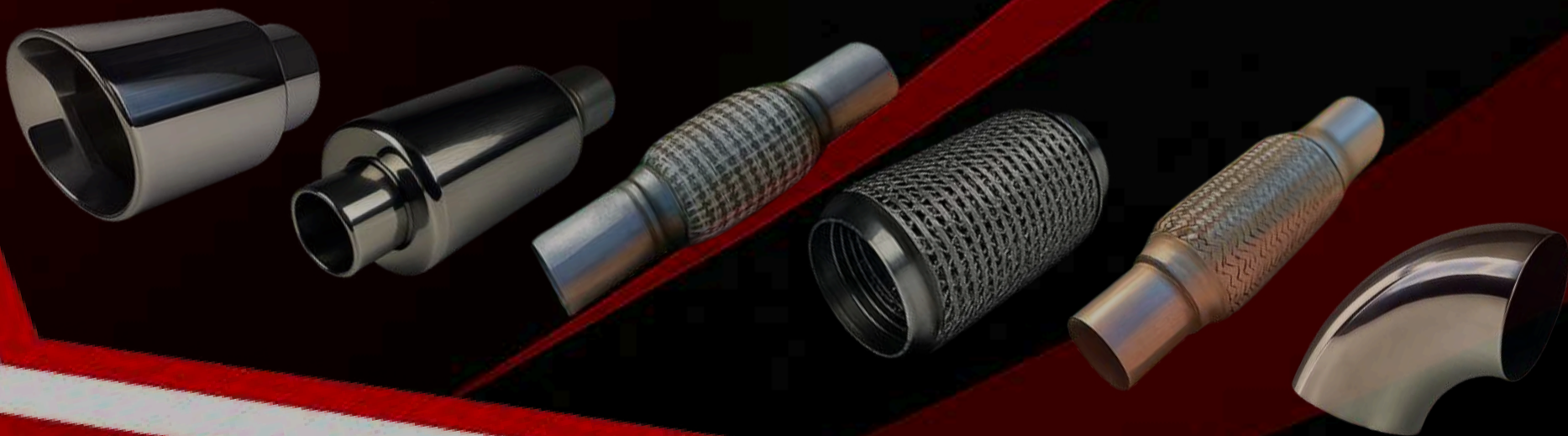

V1001

R\$ 54,00

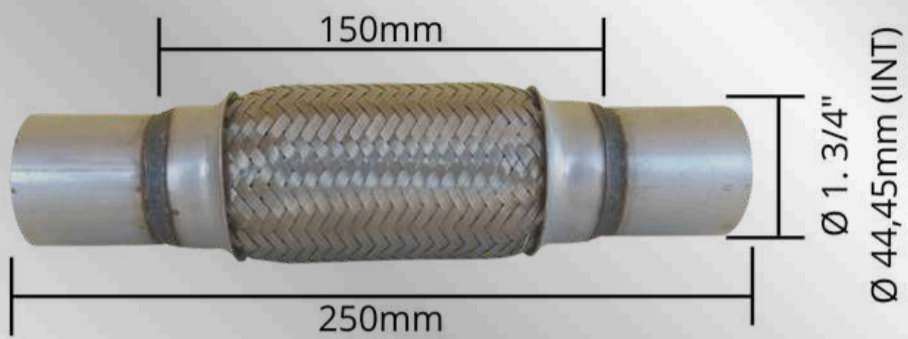

FLEXIVEL MALHA DUPLA Ø INT. 1. 3/4"
(44,45mm) X 150mm X 250mm

V1002

R\$ 45,00

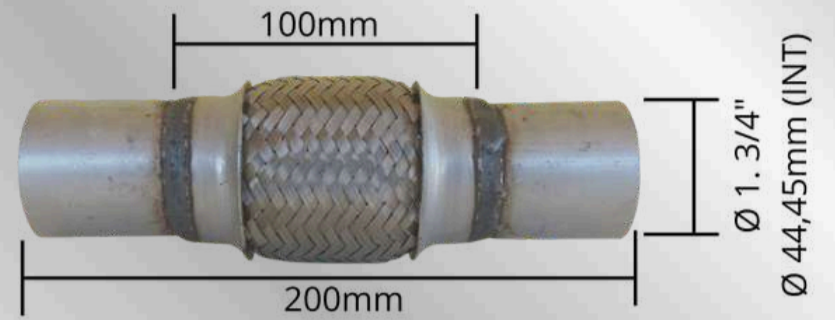

FLEXIVEL MALHA DUPLA Ø INT. 1. 3/4"
(44,45mm) X 100mm X 200mm

V1003

R\$ 73,00

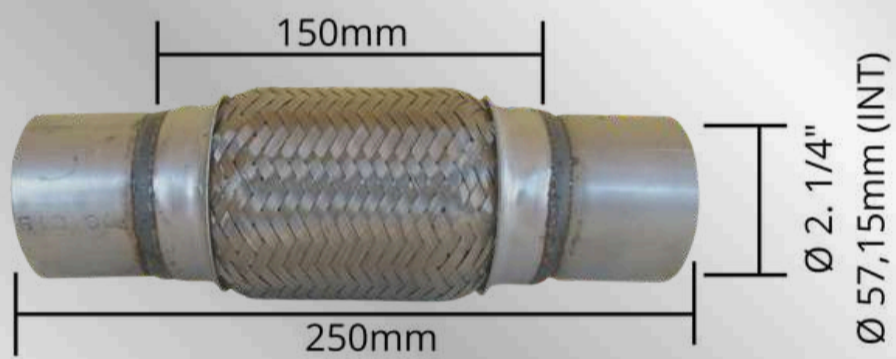

FLEXIVEL MALHA DUPLA Ø INT. 2. 1/4"
(57,15mm) X 150mm X 250mm

V1004

R\$ 83,00

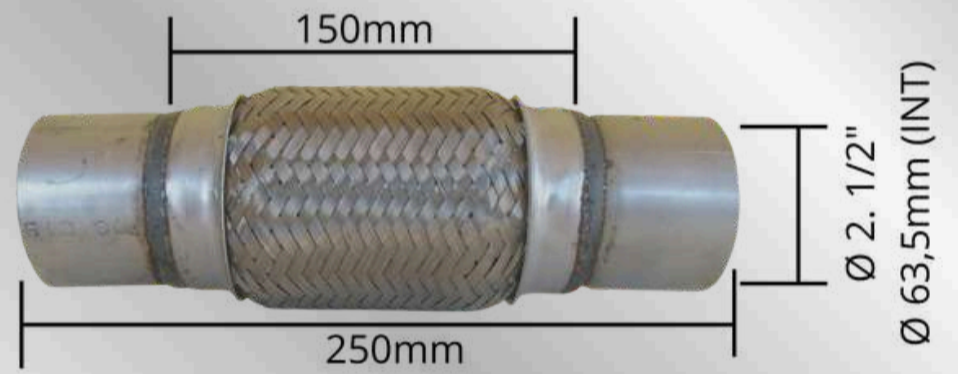

FLEXIVEL MALHA DUPLA Ø INT. 2. 1/2"
(63,5mm) X 150mm X 250mm

V1005

R\$ 93,00

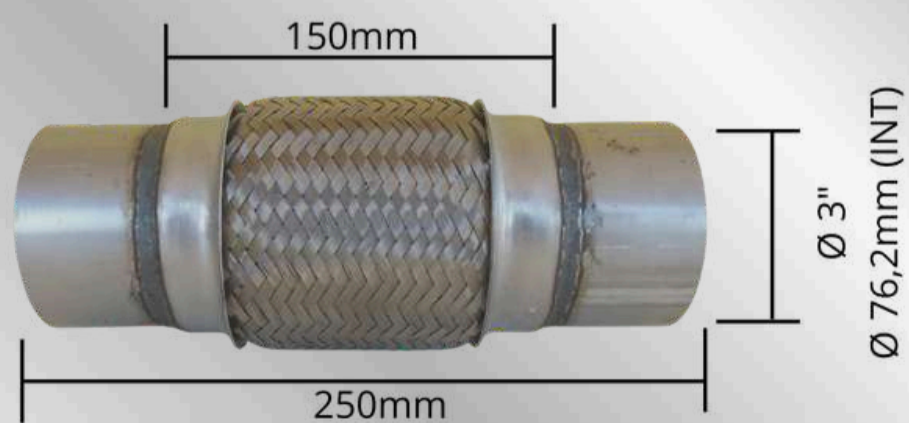

FLEXIVEL MALHA DUPLA Ø INT. 3"
(76,2mm) X 150mm X 250mm

V1006

R\$ 68,00

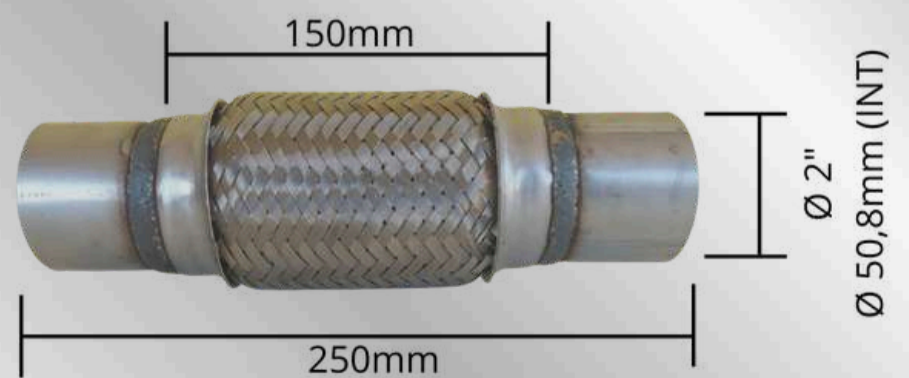

FLEXIVEL MALHA DUPLA Ø INT. 2"
(50,8mm) X 150mm X 250mm

FLEXÍVEIS

V1007

R\$ 57,00

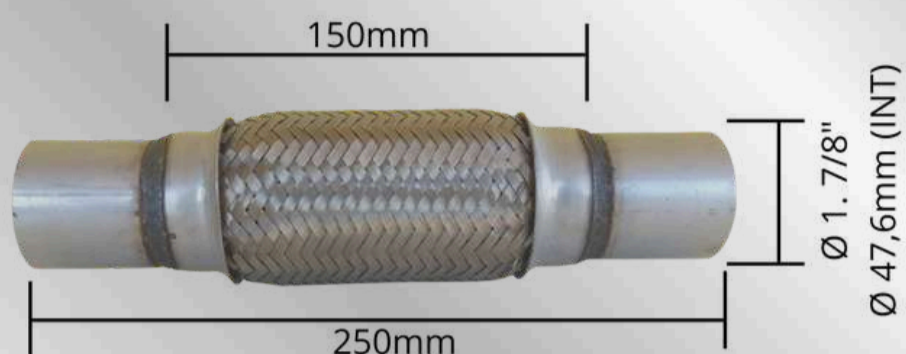

FLEXIVEL MALHA DUPLA Ø INT. 1. 7/8"
(47,6mm) X 150mm X 250mm

V1008

R\$ 50,00

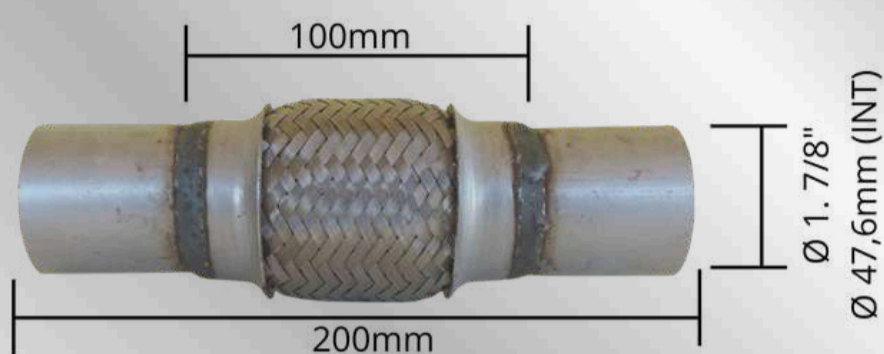

FLEXIVEL MALHA DUPLA Ø INT. 1. 7/8"
(47,6mm) X 100mm X 200mm

V1009

R\$ 58,00

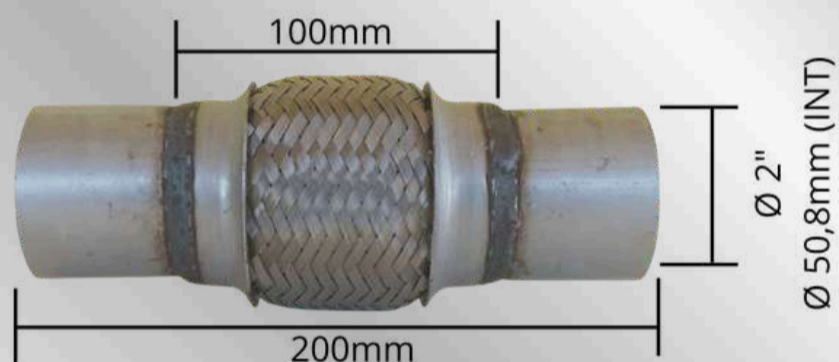

FLEXIVEL MALHA DUPLA Ø INT. 2"
(50,8mm) X 100mm X 200mm

V1010

R\$ 125,00

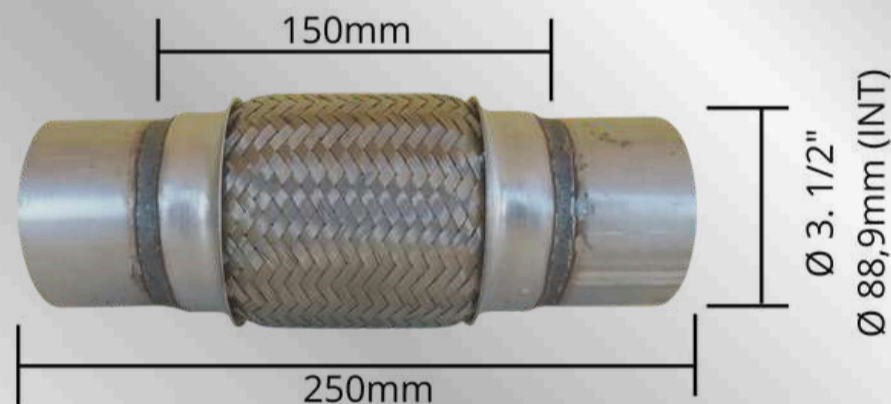

FLEXIVEL MALHA DUPLA Ø INT. 3. 1/2"
(88,9mm) X 150mm X 250mm

V1011

R\$ 150,00

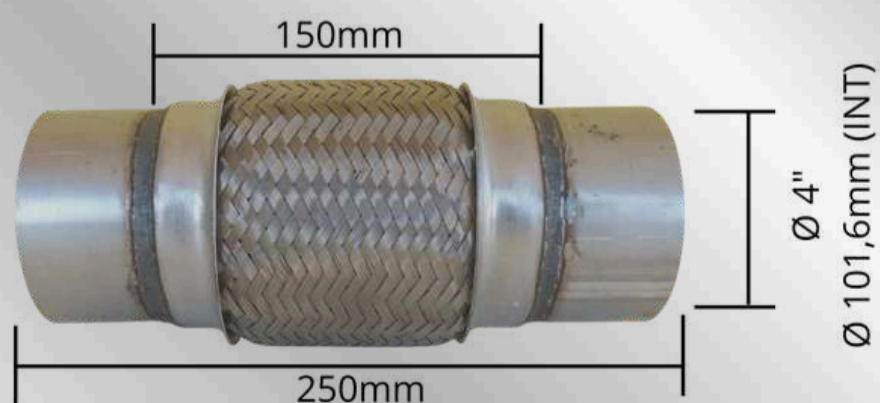

FLEXIVEL MALHA DUPLA Ø INT. 4"
(101,6mm) X 150mm X 250mm

V1012

R\$ 40,00

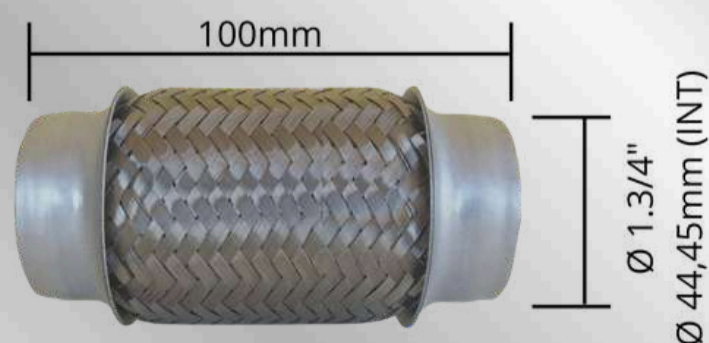

FLEXIVEL MALHA DUPLA Ø INT. 1. 3/4"
(44,45mm) X 100mm S/ TUBO

V1013

R\$ 50,00

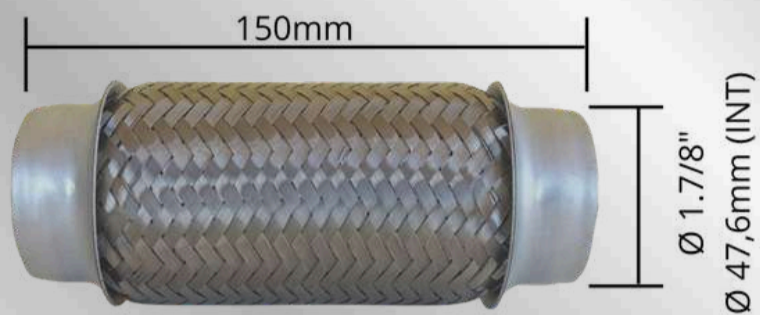

FLEXIVEL MALHA DUPLA Ø INT. 1. 7/8"
(47,6mm) X 150mm S/ TUBO

V1014

R\$ 63,00

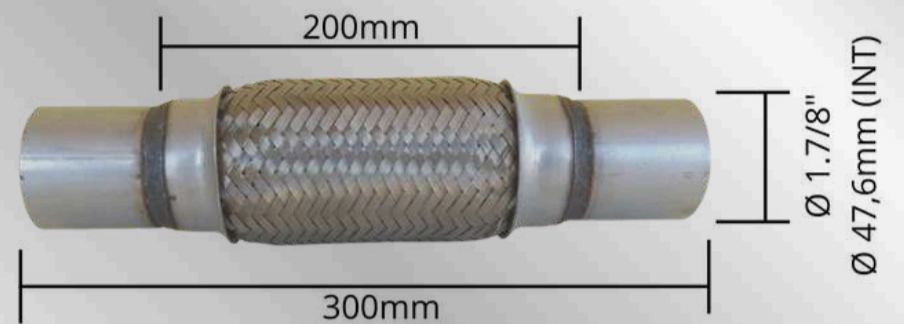

FLEXIVEL MALHA DUPLA Ø INT. 1. 7/8"
(47,6mm) X 200mm X 300mm

V1015

R\$ 75,00

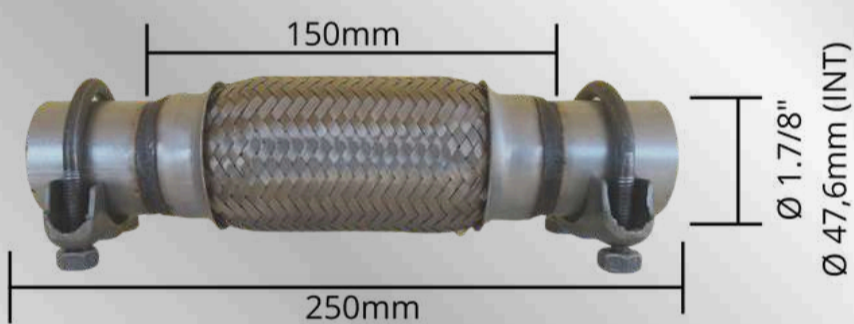

FLEXIVEL MALHA DUPLA Ø INT. 1. 7/8"
(47,6mm) X 150mm X 250mm C/
ABRAÇADEIRA

V1016

R\$ 68,00

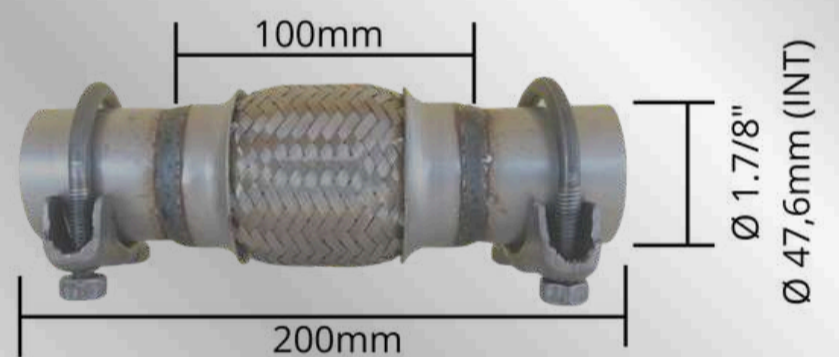

FLEXIVEL MALHA DUPLA Ø INT. 1. 7/8"
(47,6mm) X 100mm X 200mm C/
ABRAÇADEIRA

V1017

R\$ 47,00

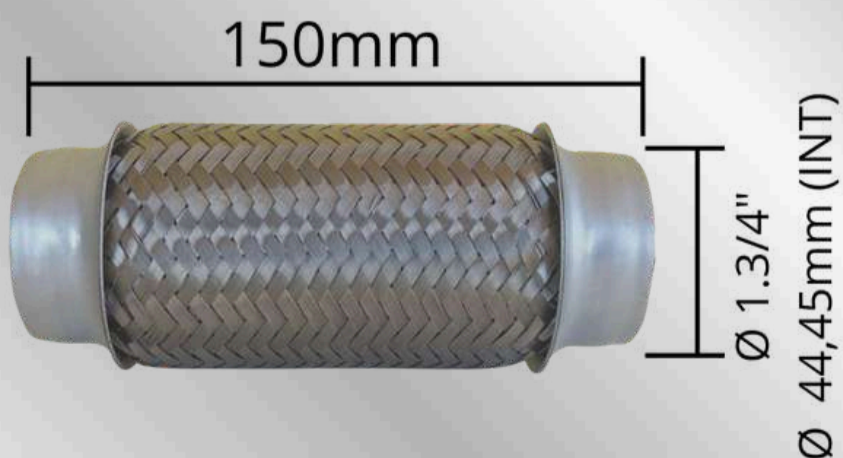

FLEXIVEL MALHA SIMPLES Ø INT. 1.
3/4" (44,45mm) X 150mm S/ TUBO

V1018

R\$ 53,00

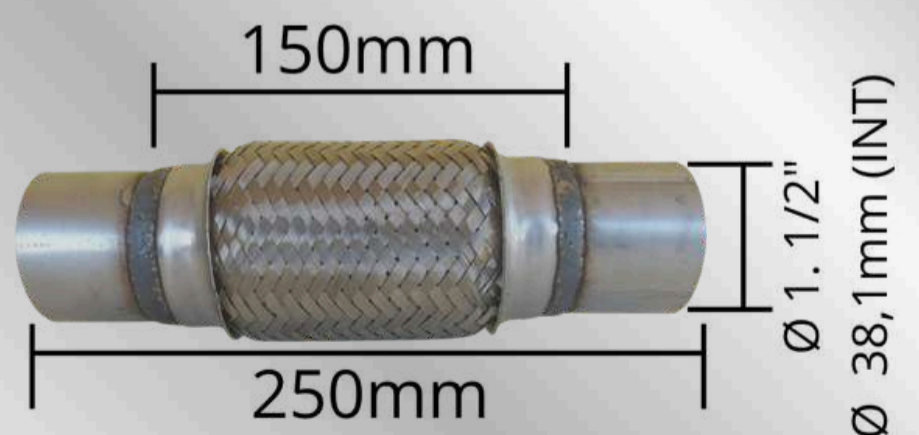

FLEXIVEL MALHA DUPLA Ø INT. 1. 1/2"
(38,1mm) X 150mm X 250mm

V1019

R\$ 53,00

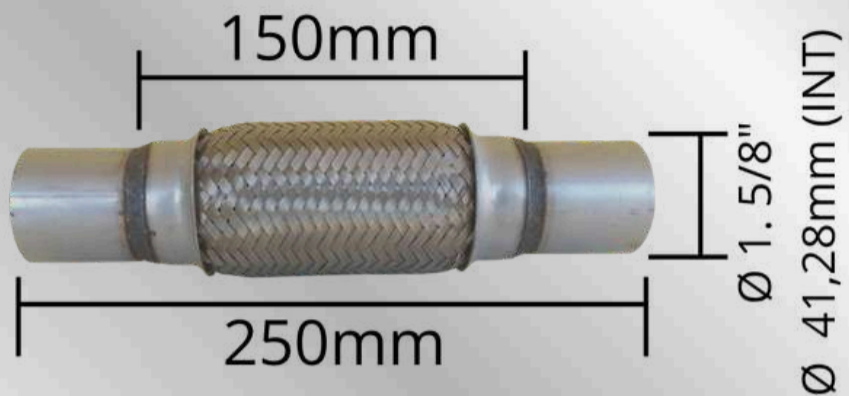

FLEXIVEL MALHA DUPLA Ø INT. 1.5/8"
(41,28mm) X 150mm X 250mm

V1020

R\$ 188,00

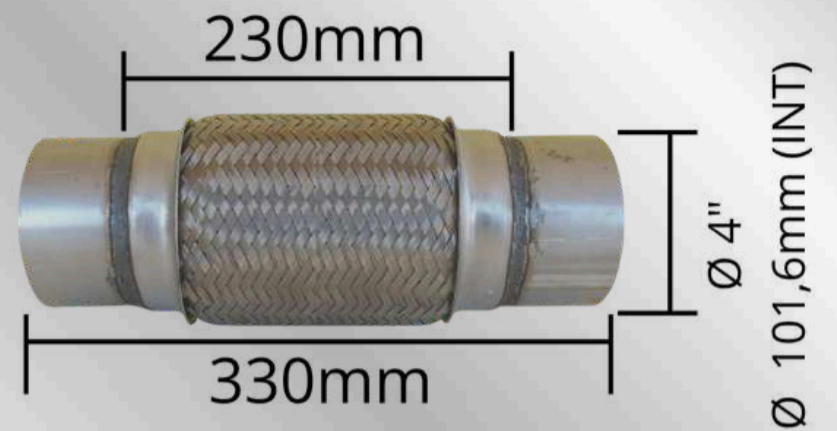

FLEXIVEL MALHA DUPLA Ø INT. 4"
(101,6mm) X 230mm X 330mm

V1021

R\$ 54,00

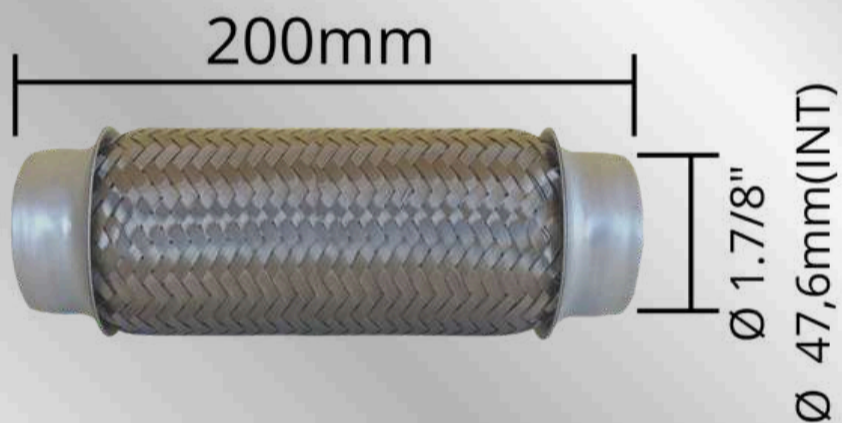

FLEXIVEL MALHA DUPLA Ø INT. 1.7/8"
(47,6mm) X 200mm S/ TUBO

V1022

R\$ 50,00

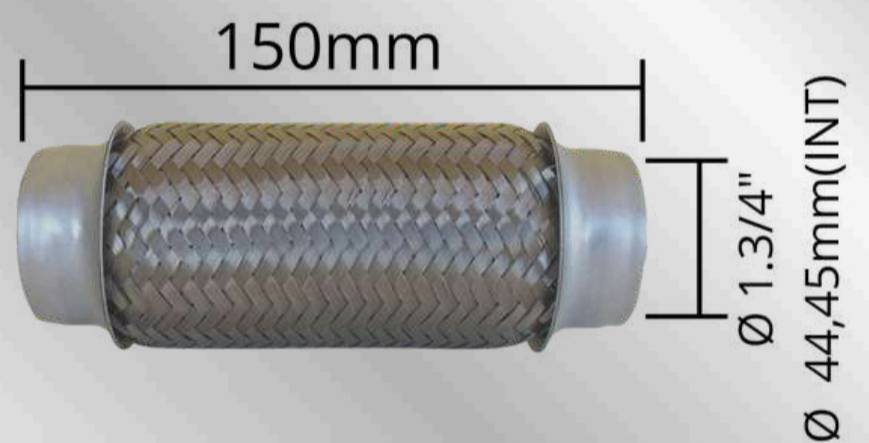

FLEXIVEL MALHA DUPLA Ø INT. 1.3/4"
(44,45mm) X 150mm S/ TUBO

V1023

R\$ 100,00

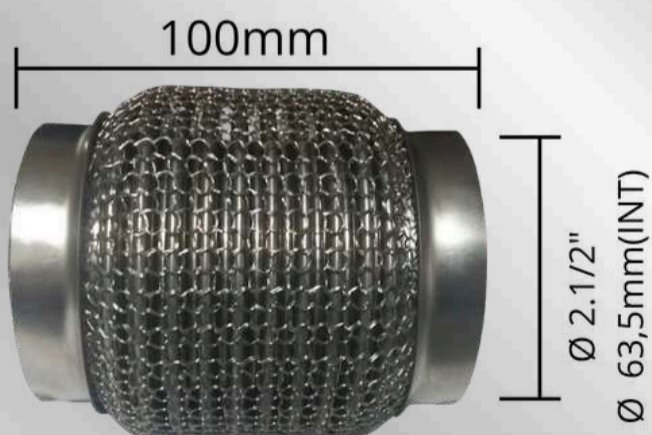

FLEXIVEL Ø INT. 2.1/2" (63,5mm) X
100mm S/ TUBO INT. GRAMPEADO

V1024

R\$ 115,00

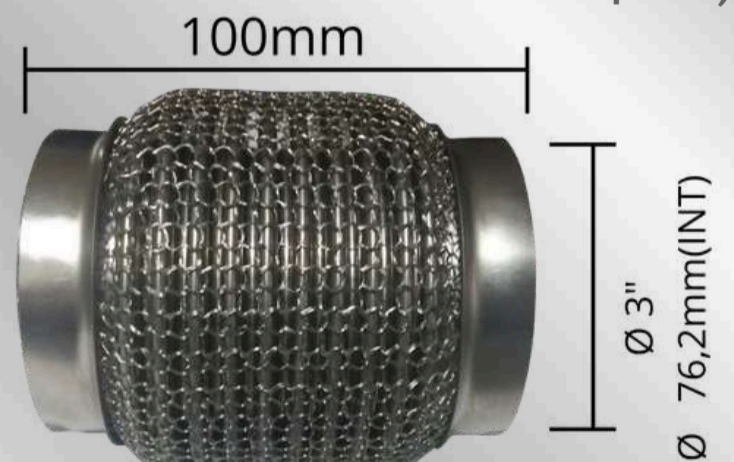

FLEXIVEL Ø INT. 3" (76,2mm) X 100mm
S/ TUBO INT. GRAMPEADO

FLEXÍVEIS

V1025

R\$ 163,00

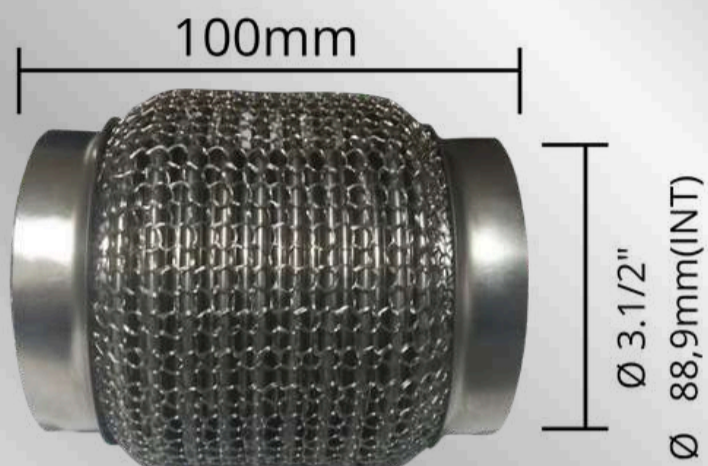

FLEXIVEL Ø INT. 3.1/2" (88,9mm) X 100mm S/ TUBO INT. GRAMPEADO

V1026

R\$ 130,00

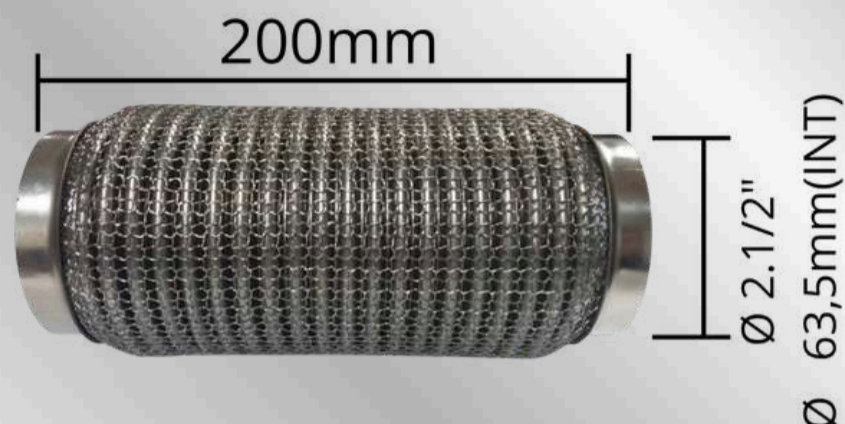

FLEXIVEL Ø INT. 2.1/2" (63,5mm) X 200mm S/ TUBO INT. GRAMPEADO

V1027

R\$ 140,00

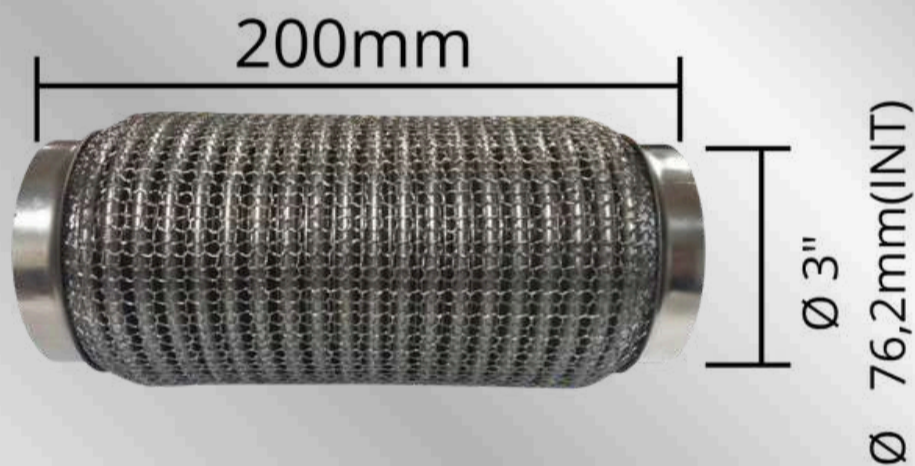

FLEXIVEL Ø INT. 3" (76,2mm) X 200mm S/ TUBO INT. GRAMPEADO

V1028

R\$ 180,00

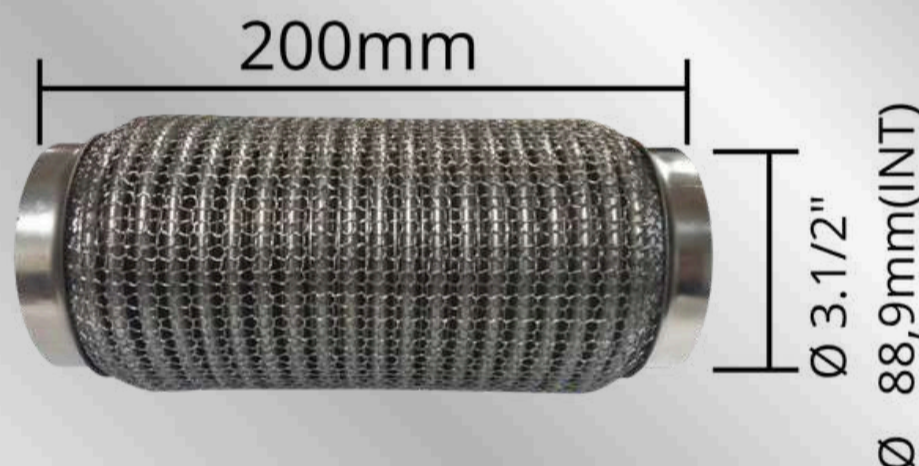

FLEXIVEL Ø INT. 3.1/2" (88,9mm) X 200mm S/ TUBO INT. GRAMPEADO

V1029

R\$ 128,00

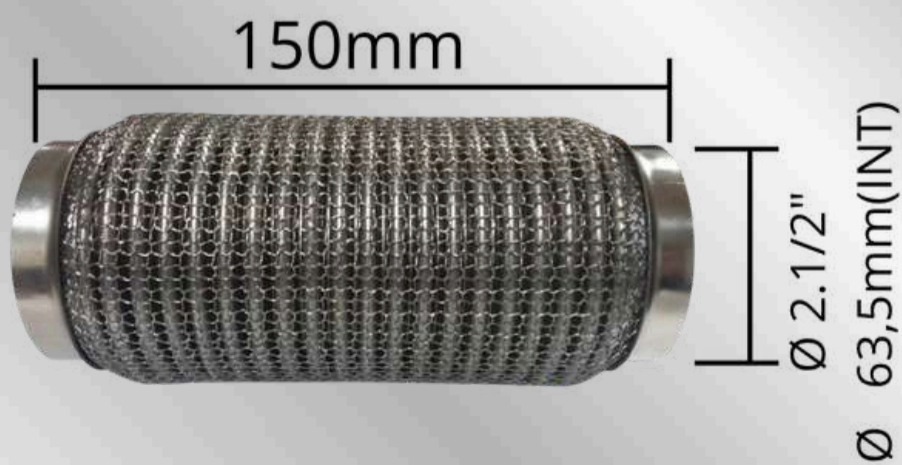

FLEXIVEL Ø INT. 2.1/2" (63,5mm) X 150mm S/ TUBO INT. GRAMPEADO

V1030

R\$ 62,00

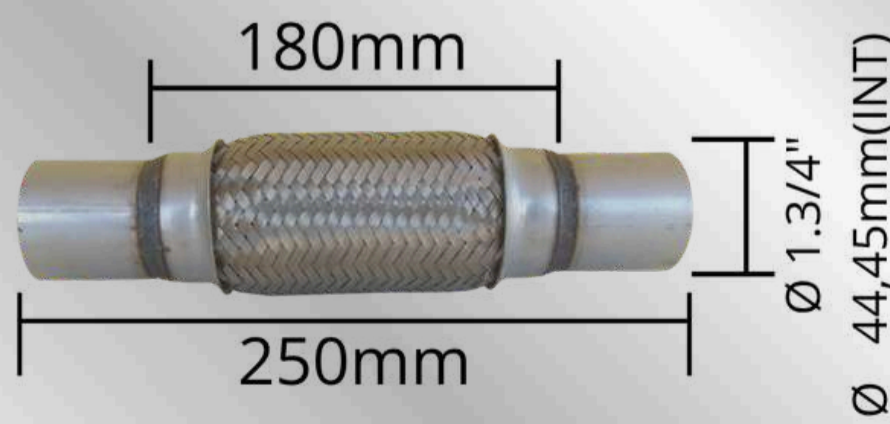

FLEXIVEL MALHA DUPLA Ø INT. 1. 3/4" (44,45mm) X 180mm X 250mm

V1031

R\$ 60,00

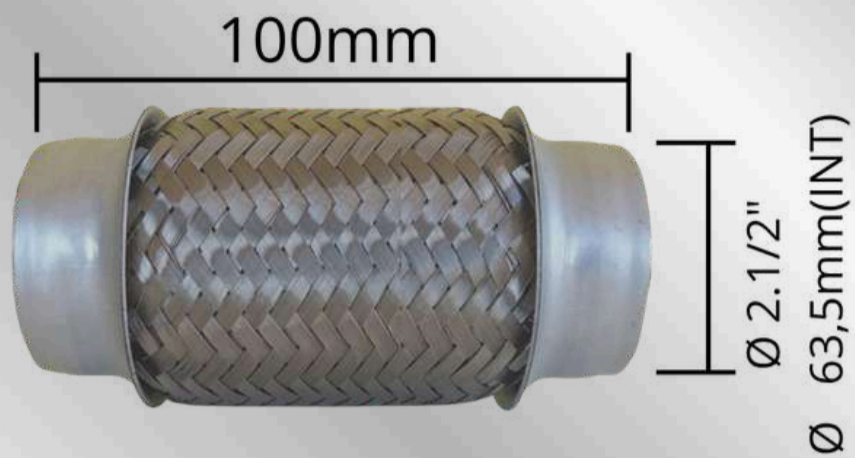

FLEXIVEL MALHA DUPLA Ø INT. 2.1/2"
(63,5mm) X 100mm S/ TUBO

V1032

R\$ 88,00

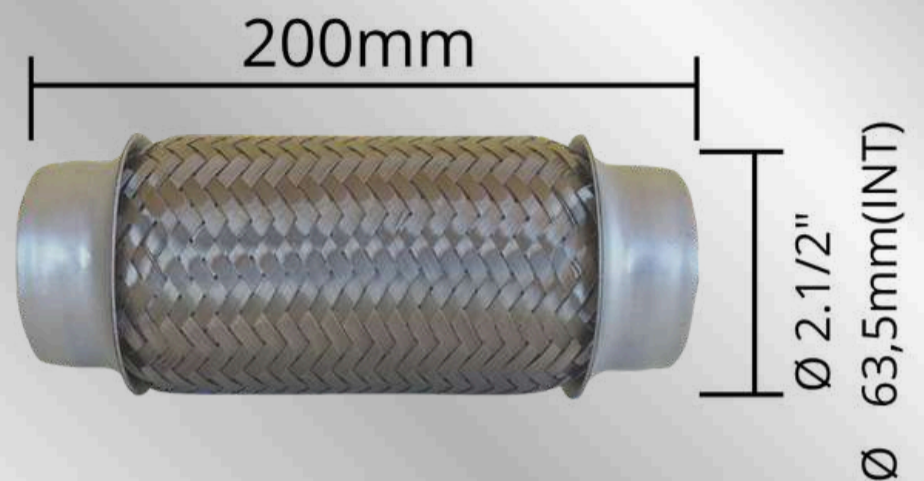

FLEXIVEL MALHA DUPLA Ø INT. 2.1/2"
(63,5mm) X 200mm S/ TUBO

V1033

R\$ 90,00

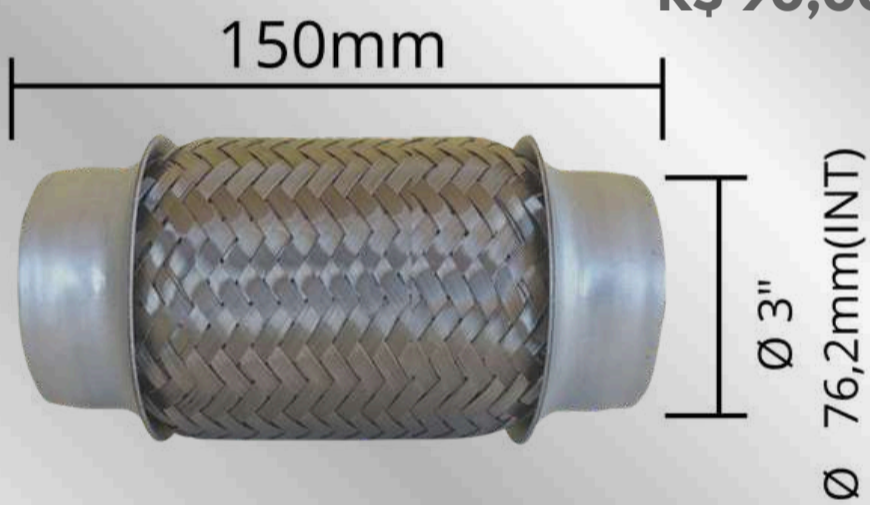

FLEXIVEL MALHA DUPLA Ø INT. 3"
(76,2mm) X 150mm S/ TUBO

V1037

R\$ 73,00

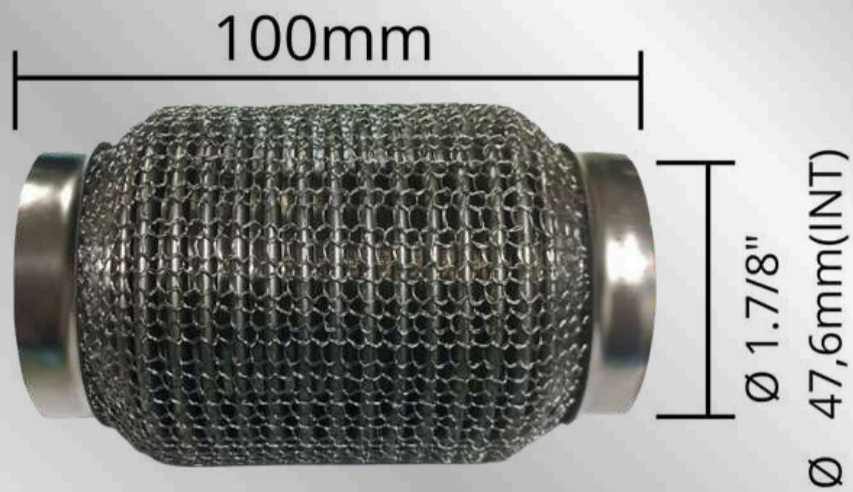

FLEXIVEL Ø INT. 1.7/8" (47,6mm) X
100mm S/ TUBO INT. GRAMPEADO

V1038

R\$ 88,00

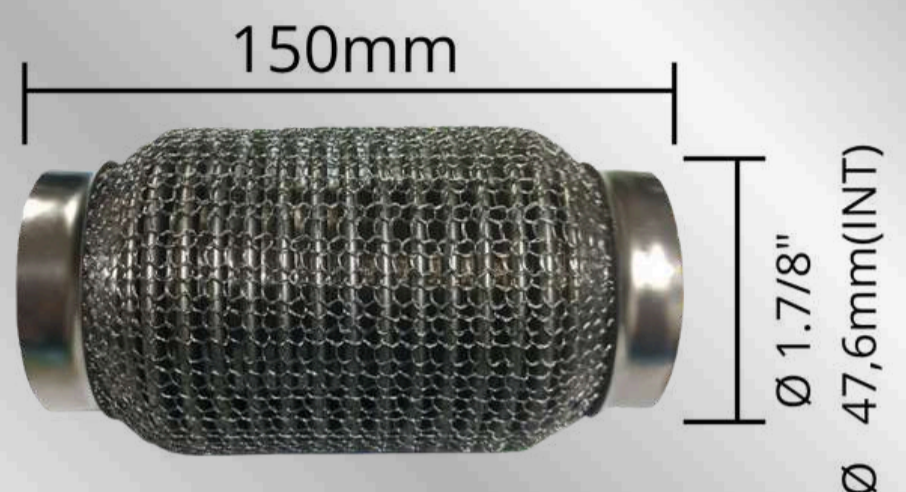

FLEXIVEL Ø INT. 1.7/8" (47,6mm) X
150mm S/ TUBO INT. GRAMPEADO

V1039

R\$ 108,00

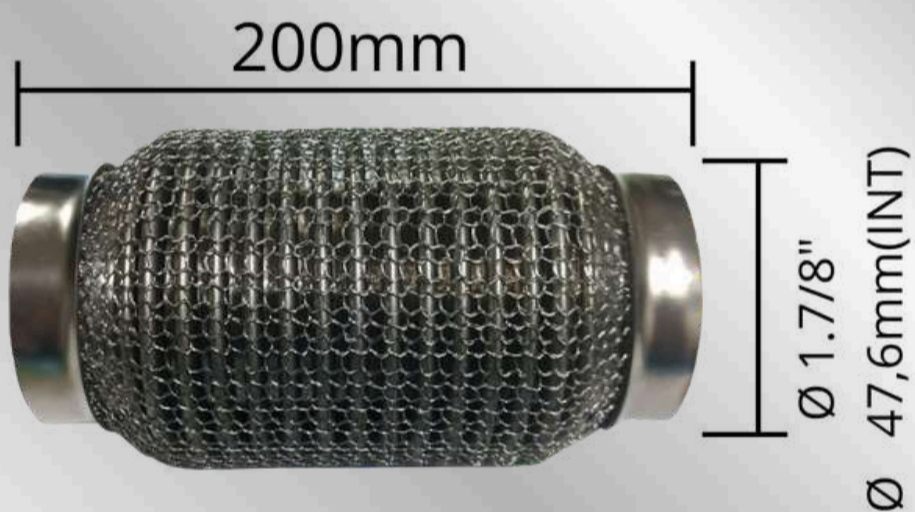

FLEXIVEL Ø INT. 1.7/8" (47,6mm) X
200mm S/ TUBO INT. GRAMPEADO

V1040

R\$ 85,00

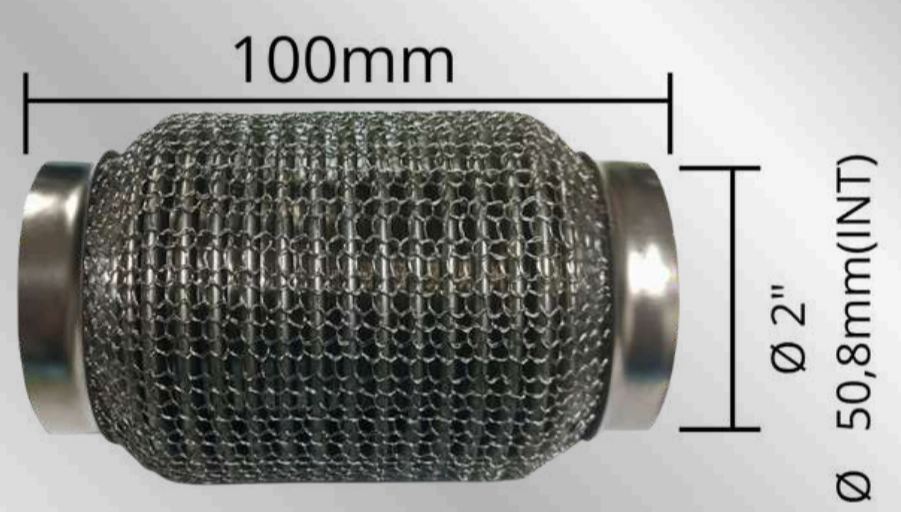

FLEXIVEL Ø INT. 2" (50,8mm) X 100mm
S/ TUBO INT GRAMPEADO

V1041

R\$ 100,00

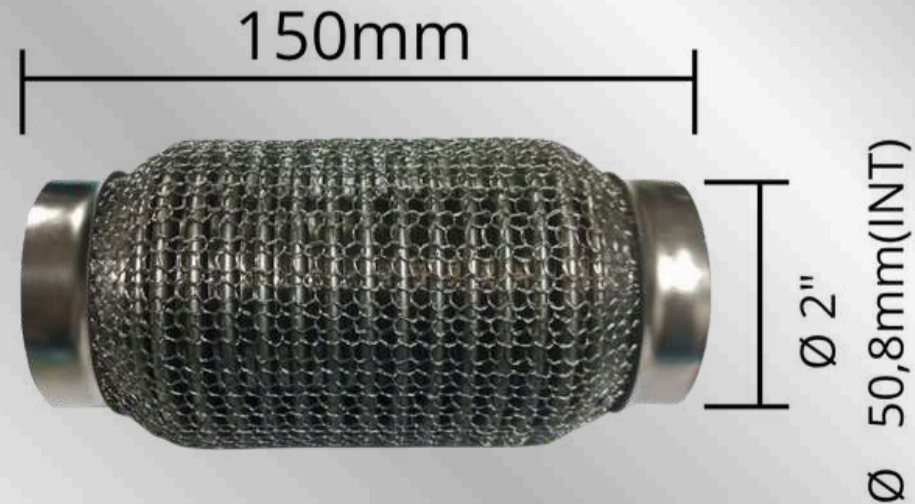

FLEXIVEL Ø INT. 2" (50,8mm) X 150mm
S/ TUBO INT GRAMPEADO

V1042

R\$ 115,00

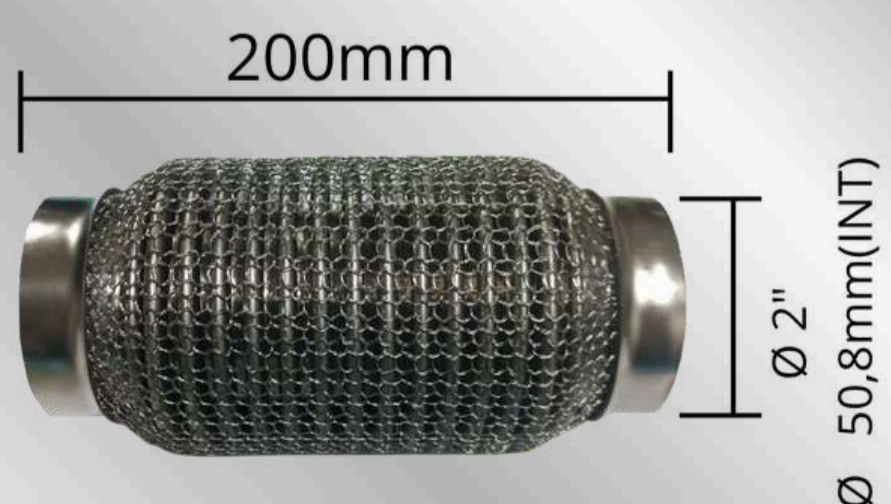

FLEXIVEL Ø INT. 2" (50,8mm) X 200mm
S/ TUBO INT GRAMPEADO

V1043

R\$ 138,00

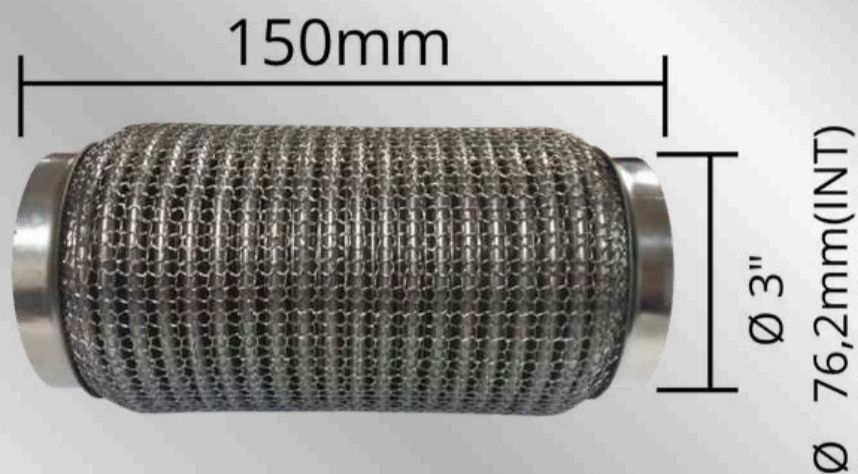

FLEXIVEL Ø INT. 3" (76,2mm) X 150mm
S/ TUBO INT. GRAMPEADO

V1044

R\$ 72,00



FLEXIVEL Ø INT. 3" (76,2mm) X
280mm-FLEX TUBING

V1045

R\$ 95,00

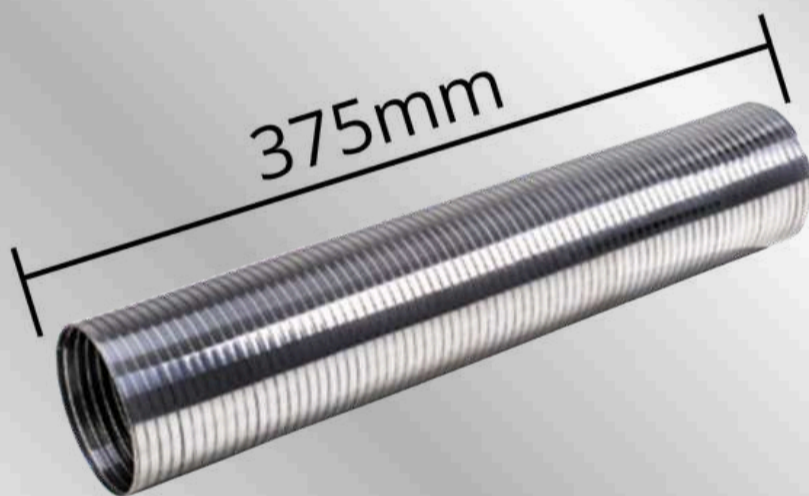

FLEXIVEL Ø INT. 3" (76,2mm) X
375mm-FLEX TUBING

V1046

R\$ 98,00



FLEXIVEL Ø INT. 3" (76,2mm) X
385mm-FLEX TUBING

V1047

R\$ 82,00



FLEXIVEL Ø INT. 3.1/2" (88,9mm) X
270mm-FLEX TUBING

V1048

R\$ 93,00



FLEXIVEL Ø INT. 3.1/2" (88,9mm) X
310mm-FLEX TUBING

FLEXÍVEIS

V1049

R\$ 125,00

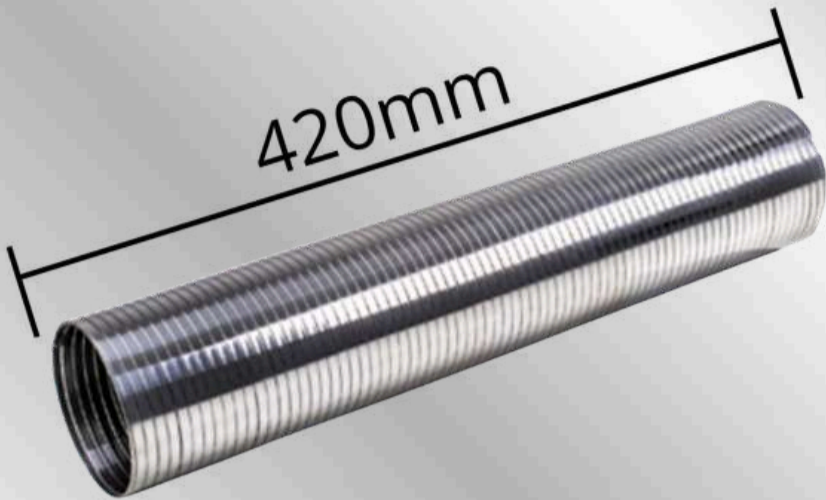

FLEXIVEL Ø INT. 3.1/2" (88,9mm) X
420mm-FLEX TUBING

V1050

R\$ 93,00



FLEXIVEL Ø INT. 4" (101,6mm) X
280mm-FLEX TUBING

V1051

R\$ 115,00



FLEXIVEL Ø INT. 4" (101,6mm) X
350mm-FLEX TUBING

V1052

R\$ 162,00

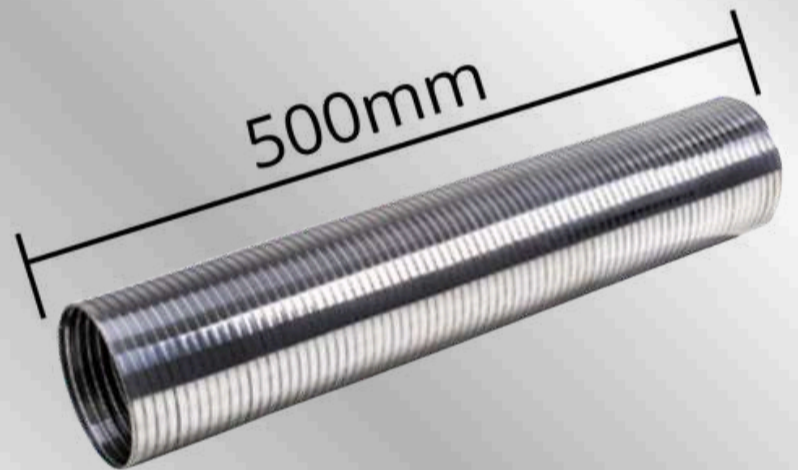

FLEXIVEL Ø INT. 4" (101,6mm) X
500mm-FLEX TUBING

V1053

R\$ 69,00

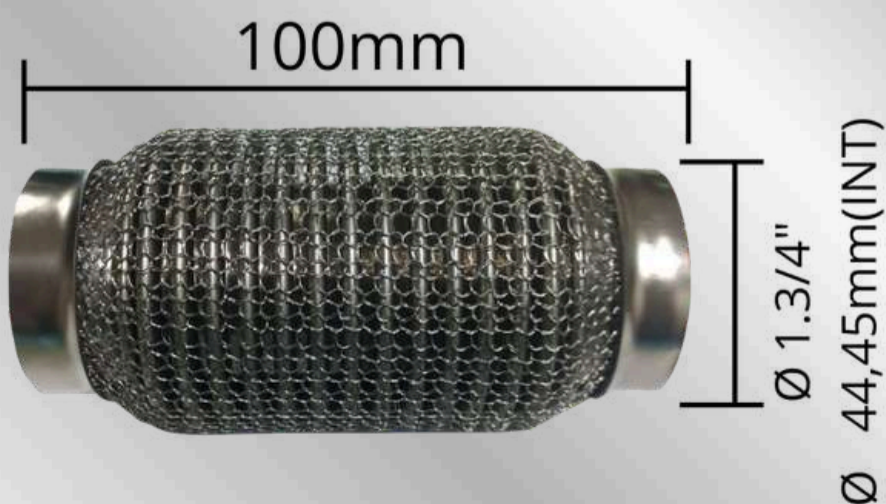

FLEXIVEL Ø INT. 1.3/4" (44,45mm) X
100mm S/ TUBO INT. GRAMPEADO

V1054

R\$ 83,00

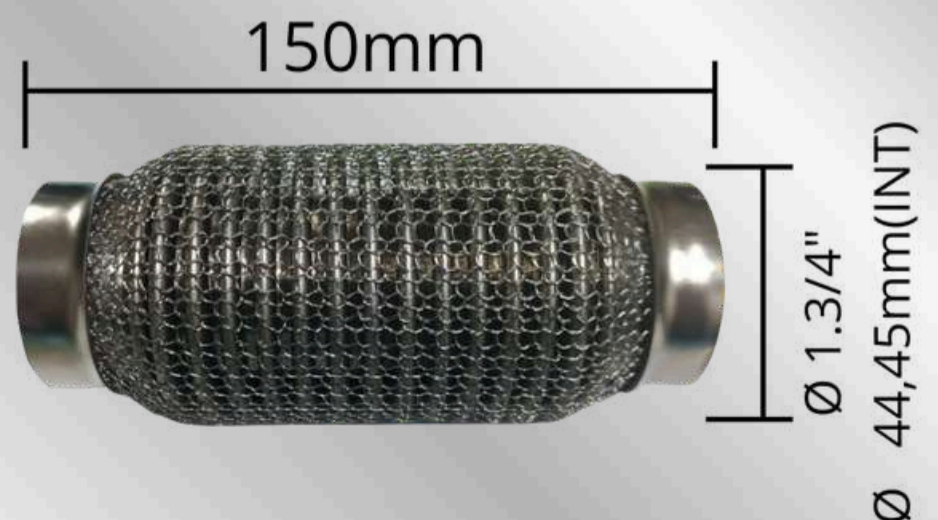

FLEXIVEL Ø INT. 1.3/4" (44,45mm) X
150mm S/ TUBO INT. GRAMPEADO

FLEXÍVEIS

V1055

R\$ 122,00

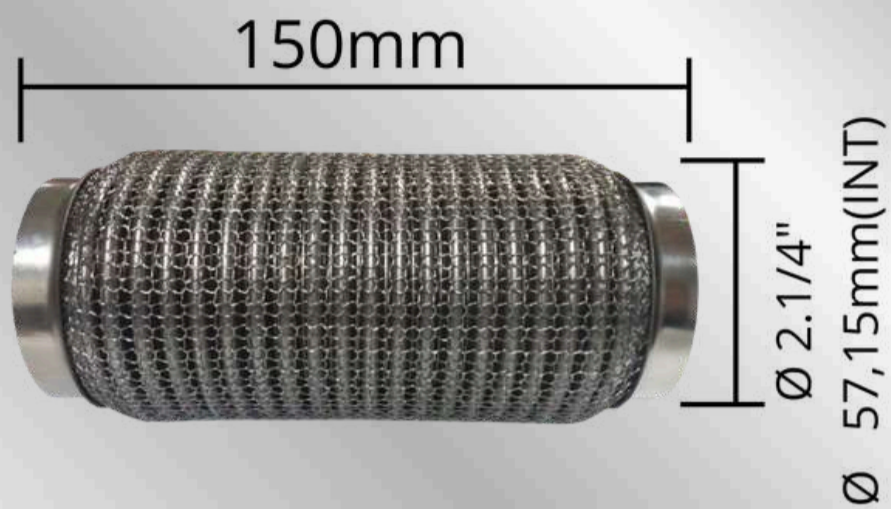

FLEXIVEL Ø INT. 2.1/4" (57,15mm) X 150mm S/ TUBO - INT. GRAMPEADO

V1056

R\$ 90,00

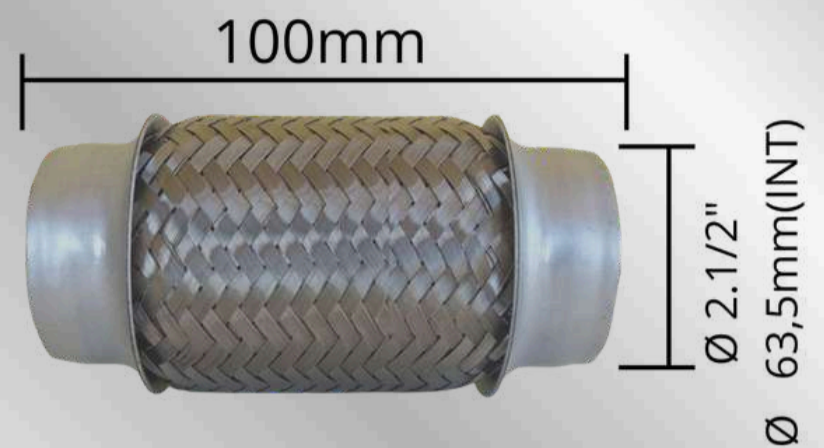

FLEXIVEL MALHA Ø INT. 2.1/2" (63,5mm) X 100mm S/ TUBO INT. GRAMPEADO

V1057

R\$ 115,00

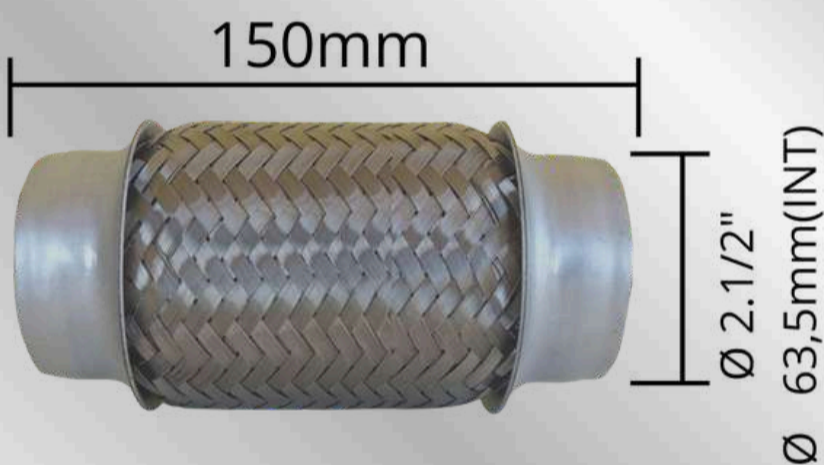

FLEXIVEL MALHA Ø INT. 2.1/2" (63,5mm) X 150mm S/ TUBO INT. GRAMPEADO

V1058

R\$ 118,00

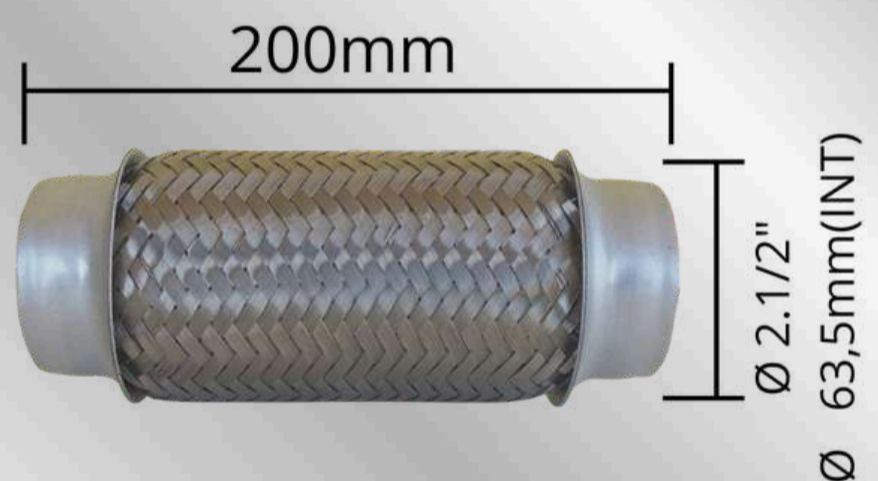

FLEXIVEL MALHA Ø INT. 2.1/2" (63,5mm) X 200mm S/ TUBO INT. GRAMPEADO

V1059

R\$ 107,00

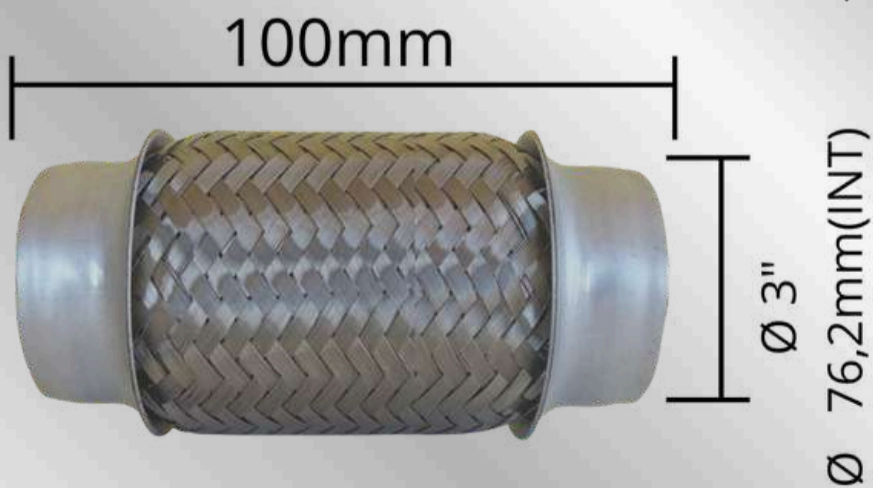

FLEXIVEL MALHA Ø INT. 3" (76,2mm) X 100mm S/ TUBO INT. GRAMPEADO

V1060

R\$ 108,00

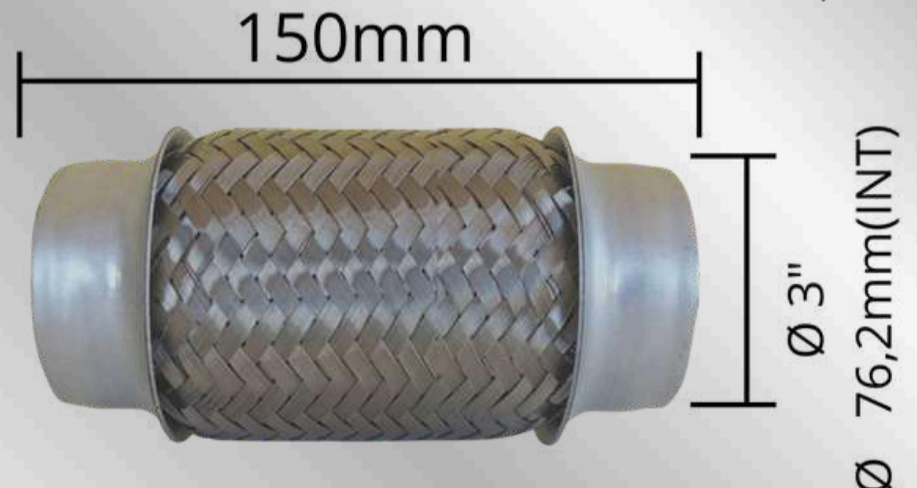

FLEXIVEL MALHA Ø INT. 3" (76,2mm) X 150mm S/ TUBO INT. GRAMPEADO

FLEXÍVEIS

V1061

R\$ 135,00

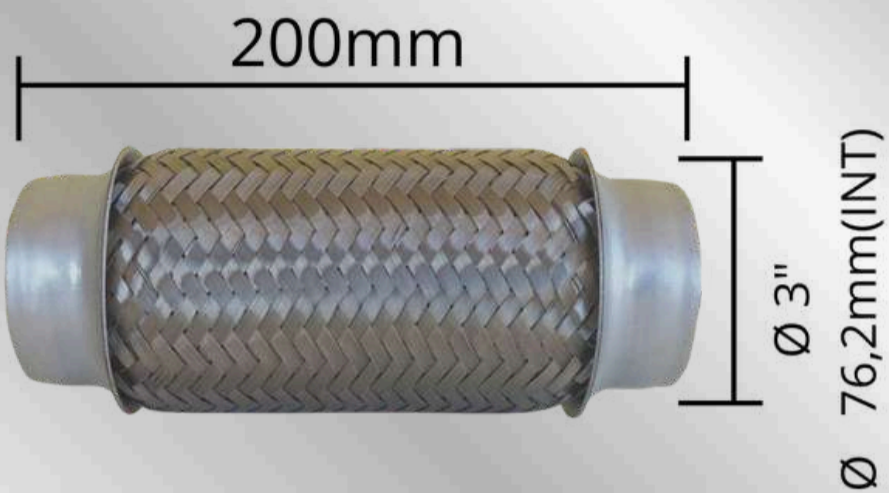

FLEXIVEL MALHA Ø INT. 3" (76,2mm) X 200mm S/ TUBO INT. GRAMPEADO

V1062

R\$ 163,00

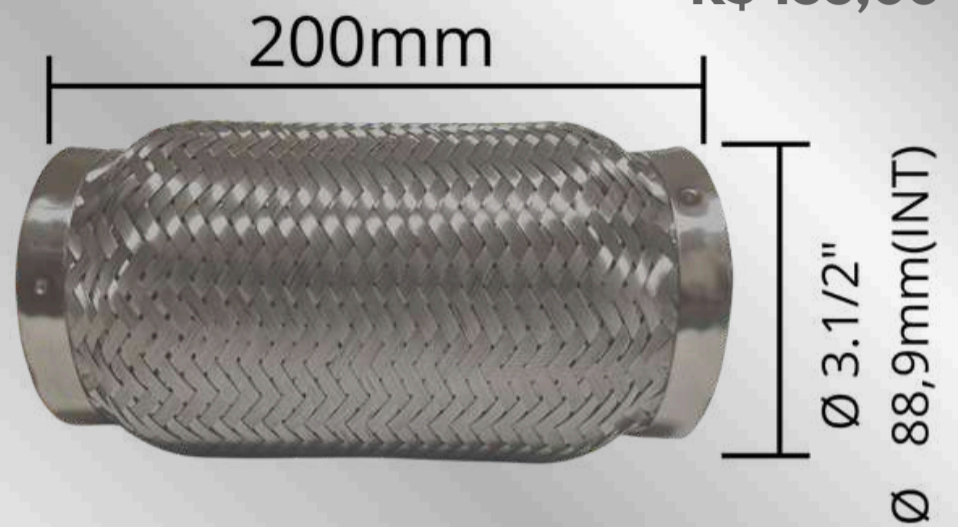

FLEXIVEL MALHA Ø INT. 3.1/2" (88,9mm) X 200mm S/ TUBO INT. GRAMPEADO

V1063

R\$ 188,00

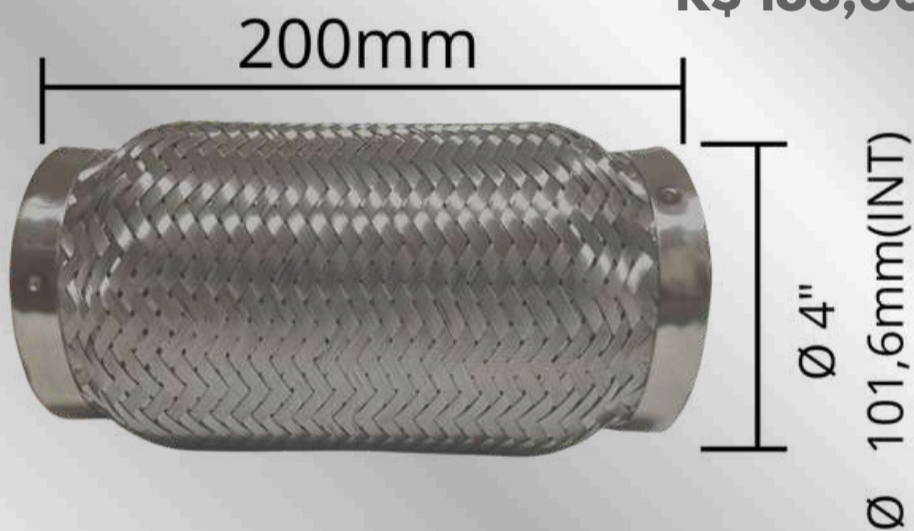

FLEXIVEL MALHA Ø INT. 4" (101,6mm) X 200mm S/ TUBO INT. GRAMPEADO

V1064

R\$ 213,00

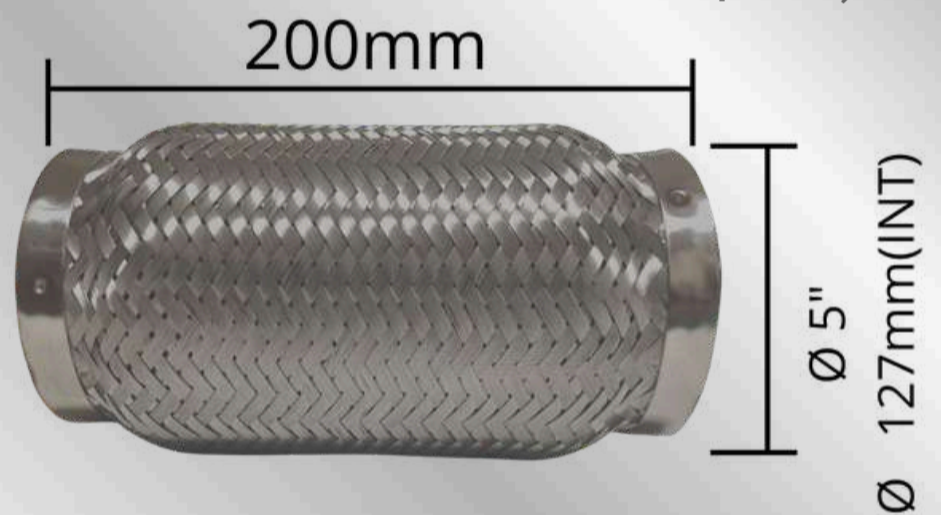

FLEXIVEL MALHA Ø INT. 5" (127mm) X 200mm S/ TUBO INT. GRAMPEADO

V1065

R\$ 213,00

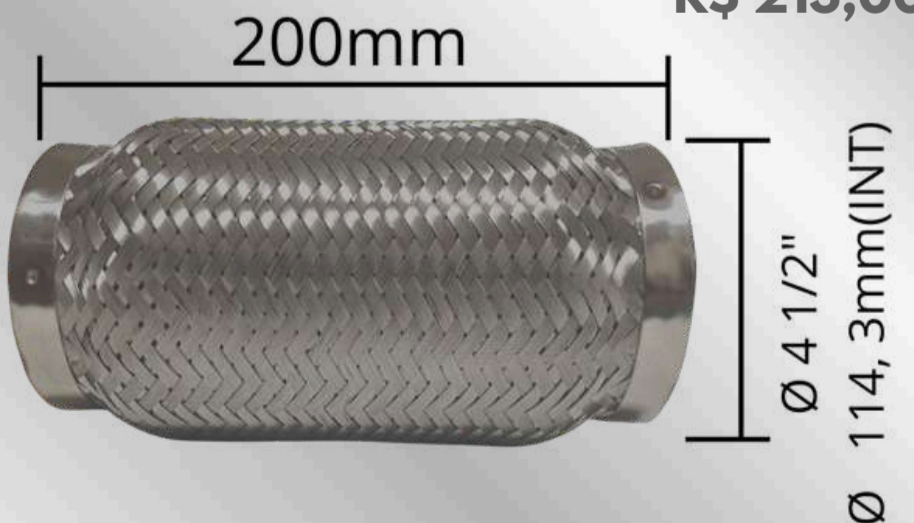

FLEXÍVEL UTIL INOX ØINT. 4 1/2" (114,3mm) X 200mm S/ TUBO - INT GRAMPEADO - MALHA

V1066

R\$ 60,00

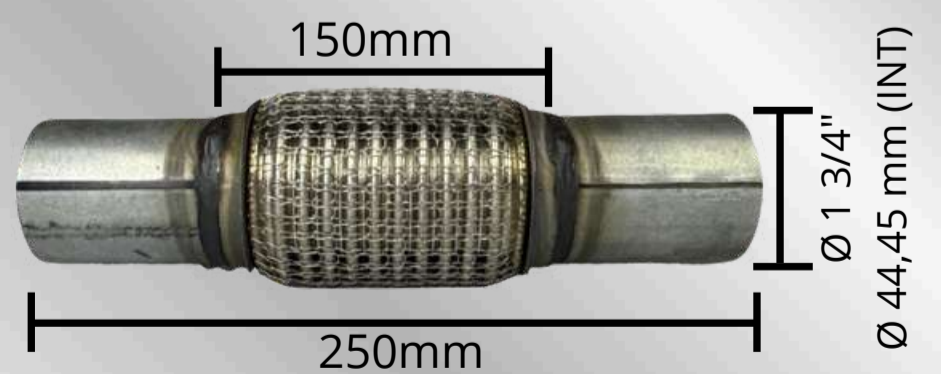

FLEXIVEL UTIL INOX Ø INT. 1 3/4" (44,45mm) X 150mm X 250mm - INT GRAMPEADO - TELA

V1067

R\$ 75,00

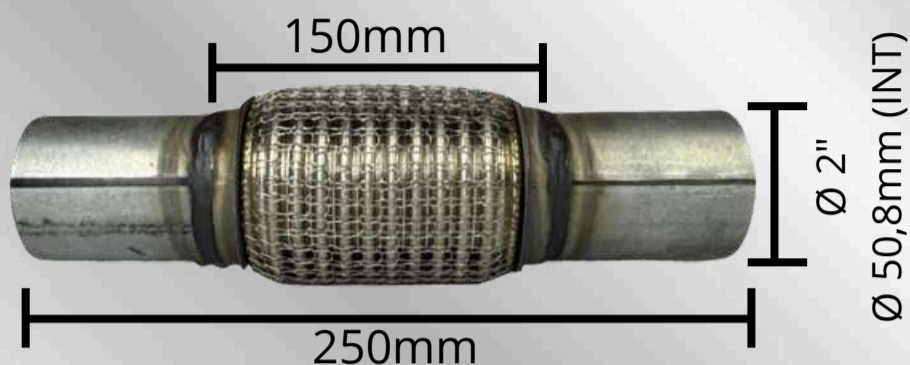

FELXIVEL UTIL INOX Ø INT. 2"
(50,8mm) X 150mm X 250mm - INT
GRAMPEADO - TELA

V1068

R\$ 63,00

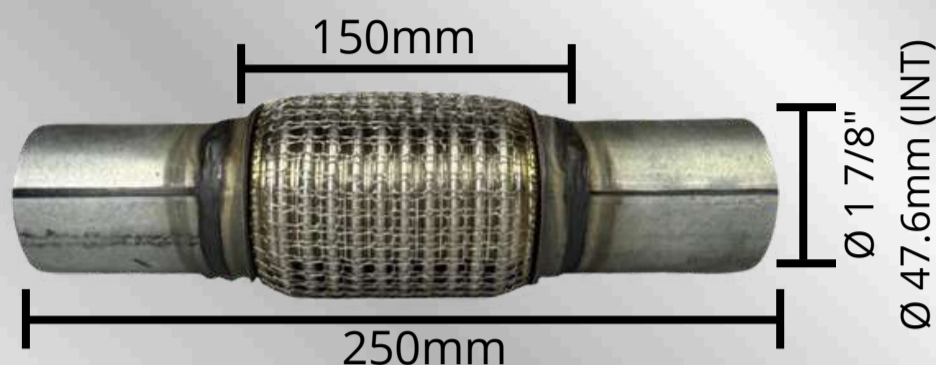

FLEXIVEL UTIL INOX Ø INT. 1 7/8"
(47.6mm) X 150mm X 250mm - INT.
GRAMPEADO - TELA

V1069

R\$ 55,00

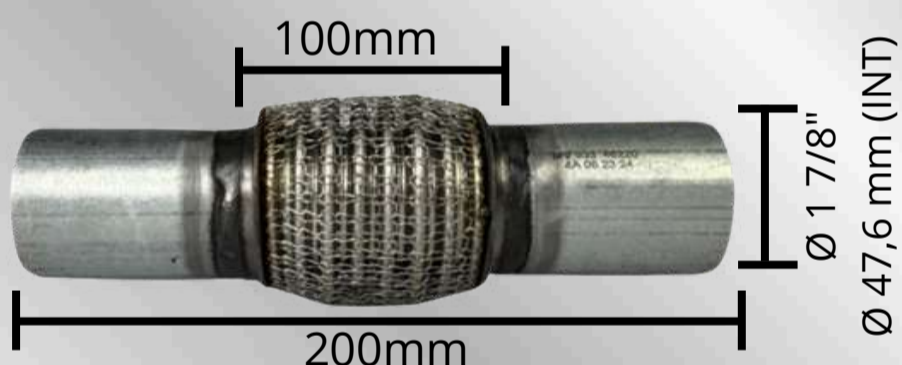

FLEXIVEL UTIL INOX Ø INT. 1 7/8"
(47,6mm) X 100mm X 200mm - INT.
GRAMPEADO - TELA

V1070

R\$ 59,00

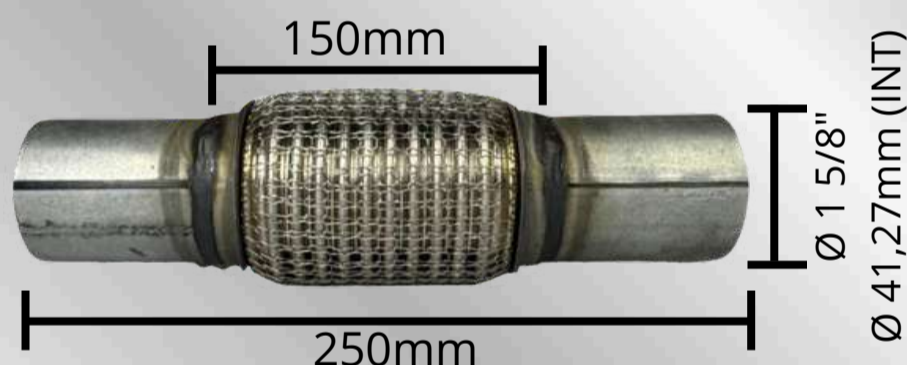

FLEXIVEL UTIL INOX Ø INT. 1 5/8"
(41,27 mm) X 150mm X 250mm - INT.
GRAMPEADO - TELA

V1071

R\$ 50,00

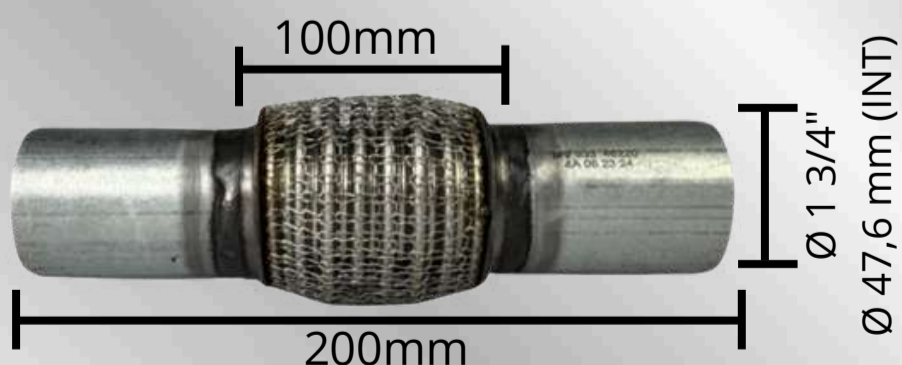

FLEXIVEL UTIL INOX Ø INT. 1 3/4"
(44,45mm) X 100mm X 200mm - INT
GRAMPEADO - TELA

V1500

R\$ 140,00



PONT. INOX UTILITARIOS DUPLA OVAL
CHANFRADA VIROLADA (1.1/2" a 2") X
3.1/2" X 215mm

V1501

R\$ 140,00



PONT. INOX UTILITARIOS DUPLA OVAL
RETA VIROLADA (1.1/2" a 2") X 3.1/2"
X 215mm

V1502

R\$ 152,00



PONT. INOX UTILITARIOS DUPLA
REDONDA RETA VIROLADA (1.1/2" a 2")
X 3" X 210mm

V1503

R\$ 140,00



PONT. INOX UTILITARIOS DUPLA
REDONDA CHANFRADA VIROLADA
(1.1/2" a 2") X 3.1/2" X 215mm

V1504

R\$ 138,00



PONT. INOX UTILITARIOS OVAL
CHANFRADA VIROLADA (1.1/2" a 2") X
5.1/4" X 170mm - COM DEFLETOR

V1505

R\$ 74,00



PONT. INOX UTILITARIOS OVAL
CHANFRADA VIROLADA (1.3/4" a
2.1/4") X 3.1/2" X 160mm ARTICULADA

PONTEIRAS

V1507

R\$93,00



PONT. INOX UTILITARIOS OVAL
CHANFRADA VIROLADA (2.1/4" a
2.7/8") X 4" X 190mm --COM
ABAFADOR--

V1508

R\$ 80,00



PONT. INOX UTILITARIOS REDONDA
CHANFRADA (1.3/4" a 2.1/4") X 3" X
180mm

V1509

R\$ 97,00



PONT. INOX UTILITARIOS REDONDA
CHANFRADA VIROLADA (1.3/4" a
2.1/4") X 3.1/2" X 190mm --COM
ELEMENTO--

V1510

R\$ 110,00



PONT. INOX UTILITARIOS REDONDA
CHANFRADA (2.1/4" a 2.7/8") X 4" X
180mm

V1511

R\$ 110,00



PONT. INOX UTILITARIOS REDONDA
CHANFRADA (2.1/4" a 2.7/8") X 4" X
190mm --COM ABAFADOR--

V1512

R\$ 60,00



PONT. INOX UTILITARIOS REDONDA
CHANFRADA (2" a 2.1/2") X 3" X
160mm

V1514

R\$70,00



PONT. INOX UTILITARIOS REDONDA
CHANFRADA VIROLADA (1.1/2" a 2") X
3" X 150mm --COM ELEMENTO
TURBO--

V1518

R\$ 92,00



PONT. INOX UTILITARIOS REDONDA
CHANFRADA VIROLADA (2" a 2.7/8") X
3.1/2" X 140mm

V1520

R\$ 60,00

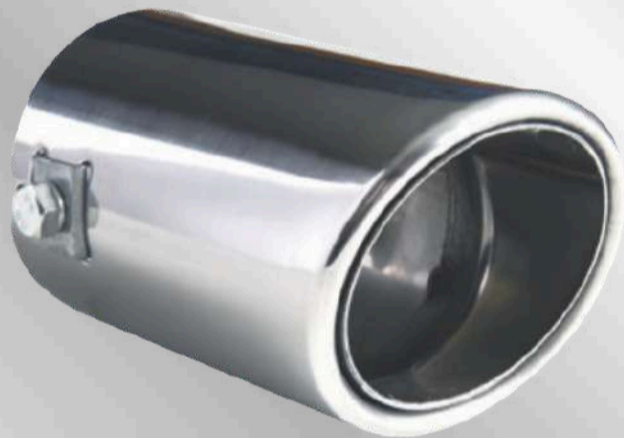

PONT. INOX UTILITARIOS REDONDA
CHANFRADA VIROLADA (2" a 2.1/2") X
3" X 125mm --COM ELEMENTO--

V1532

R\$ 80,00



PONT. INOX UTILITARIOS REDONDA
CHANFRADA 2.1/2" X 3.1/2" X 145mm
- AZULADA - SOLDADA

V1533

R\$ 197,00



PONT. INOX UTILITARIOS DUPLA
CHANFRADA VIROLADA 1.1/2" a 2" X
3.1/2" X 215mm - AZULADA

V1534

R\$ 75,00

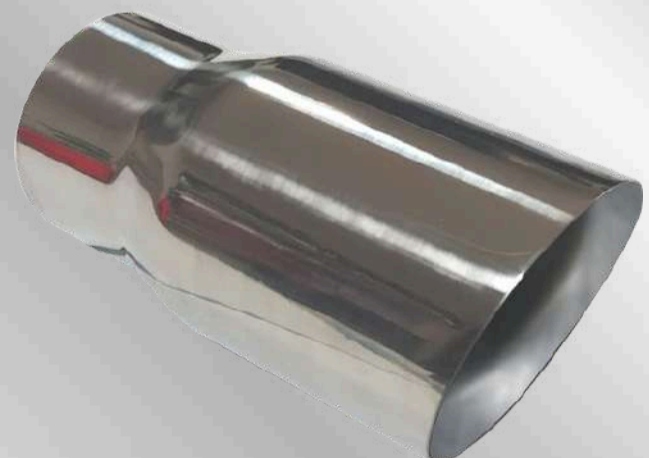

PONT. INOX UTILITARIOS REDONDA
CHANFRADA 2" X 2.1/2" X 145mm -
SOLDADA - C/ CAPA DUPLA

V1535

R\$84,00

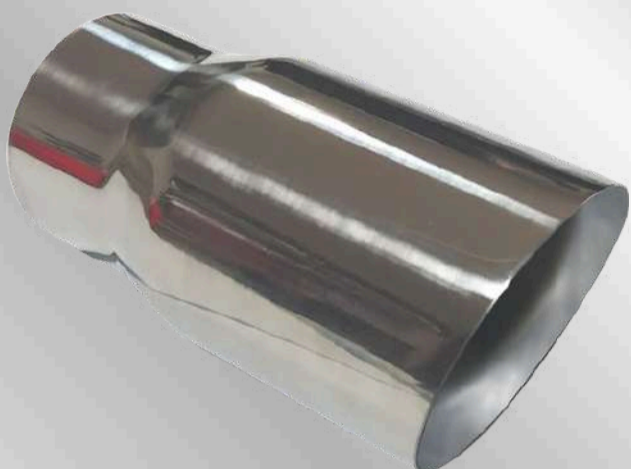

PONT. INOX UTILITARIOS REDONDA
CHANFRADA 2.1/2" X 3" X 145mm -
SOLDADA - C/ CAPA DUPLA

V1536

R\$ 102,00



PONT. INOX UTILITARIOS REDONDA
CHANFRADA 2.1/2" X 3.1/2" X 145mm
- SOLDADA - C/ CAPA DUPLA

V1537

R\$ 109,00



PONT. INOX UTILITARIOS REDONDA
CHANFRADA 3" X 4" X 145mm -
SOLDADA - C/ CAPA DUPLA

V1538

R\$ 137,00

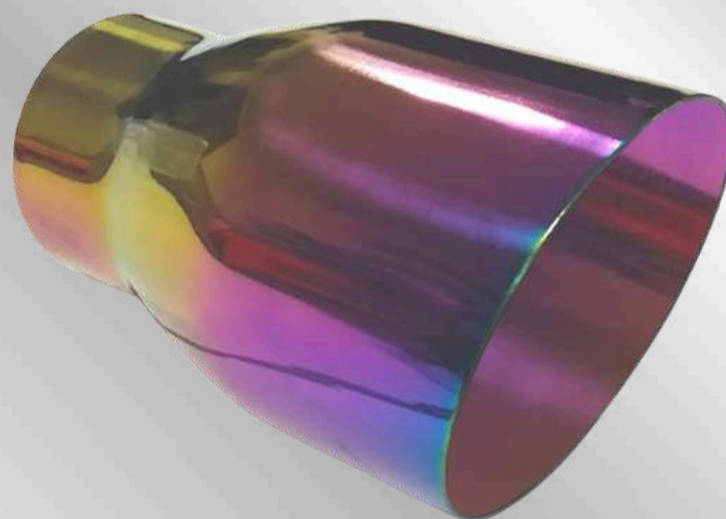

PONT. INOX UTILITARIOS REDONDA
CHANFRADA 2.1/2" X 3.1/2" X 145mm
- AZULADA - SOLDADA C/ CAPA DUPLA

V1539

R\$ 90,00

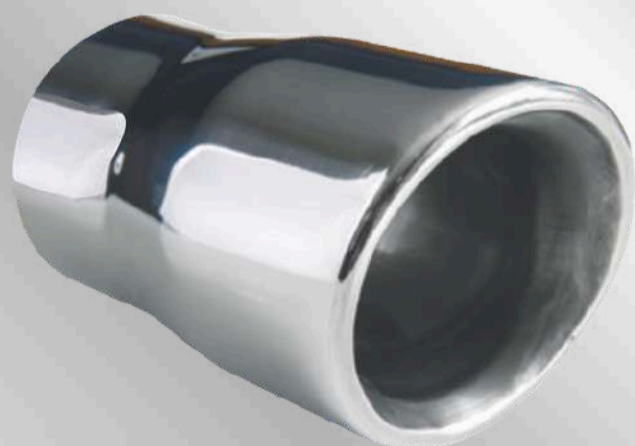

PONT. INOX UTILITARIOS REDONDA
CHANFRADA VIROLADA (1.3/4") X 3" X
125mm - SOLDADA

V1540

R\$ 93,00



PONT. INOX UTILITARIOS OVAL
CHANFRADA VIROLADA (1.7/8" A
2.1/2") x 3.1/2" X 155mm - CAPA DUPLA

V1541

R\$88,00



PONT. INOX UTILITARIOS OVAL
CHANFRADA VIROLADA (1.1/2" a 2") X
3" X 150mm - CAPA DUPLA

V1542

R\$ 123,00



PONT. INOX UTILITARIOS OVAL
CHANFRADA VIROLADA (1.1/2" a 2") X
3" X 150mm - CAPA DUPLA

V1543

R\$ 85,00



PONT. INOX UTILITARIOS OVAL
CHANFRADA VIROLADA (1.1/2" A 2") x
3.3/4" X 165mm

V1544

R\$ 190,00



PONT. INOX UTILITARIOS DUPLA
REDONDA CHANFRADA VIROLADA
(1.1/2" a 2") X 3.1/2" X 265mm

V1600

R\$ 102,00



PONT. INOX UTILITARIOS REDONDA
CHANFRADA 2" (50.8mm) X 2.1/2"
(63.5mm) X 130mm - CAPA DUPLA

V1601

R\$ 113,00



PONT. INOX UTILITARIOS REDONDA
CHANFRADA 2" (50.8mm) X 3"
(76.2mm) X 130mm - CAPA DUPLA

V1602

R\$ 190,00



PONT. INOX UTILITARIOS REDONDA
CHANFRADA 2. 1/4" (57.15mm) X
3.1/2" (88.9mm) X 130mm - CAPA
DUPLA

V1603

R\$ 225,00



PONT. INOX UTILITARIOS REDONDA
CHANFRADA 2.1/2" (63.5mm) X 4"
(101.6mm) X 130mm - CAPA DPLA

V1604

R\$ 107,00



PONT. INOX UTILITARIOS REDONDA
CHANFRADA 2" (50.8mm) X 3"
(76.2mm) X 130mm CAPA DUPLA -
VIROLADA

V1605

R\$ 90,00



PONT. INOX UTILITARIOS REDONDA
CHANFRADA 2.1/2" (63.5mm) X 3"
(76.2mm) X 100mm - VIROLADA

V1606

R\$ 108,00



PONT. INOX UTILITARIOS DUPLA
REDONDA CHANFRADA 2.1/2"
(63.5mm)X 3.1/2" (88.9mm) X 120mm -
VIROLADA

V1607

R\$ 113,00



PONT. INOX UTILITARIOS DUPLA
REDONDA CHANFRADA 2.1/2"
(63.5mm)X 4" (101.6mm) X 120mm -
VIROLADA

V1608

R\$ 248,00



PONT. INOX UTILITARIOS REDONDA
CHANFRADA 3.1/2" (88.9mm) X 5"
(127mm) X 160mm CAPA DUPLA -
VIROLADA

V1609

R\$ 450,00



PONT. INOX UTILITARIOS DUPLA
REDONDA 1.1/2" (63.5mm) X 3.1/2"
(88.9mm) X 248mm CAPA DUPLA -
VIROLADA

V1610

R\$ 370,00

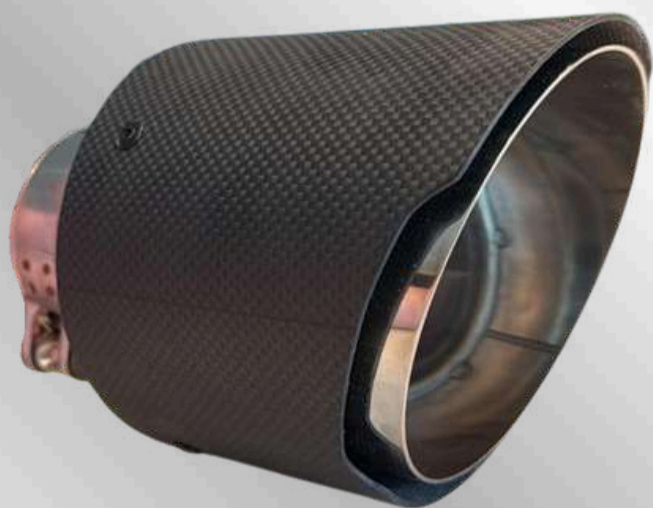

PONT INOX UTILITARIOS REDONDA
2 1/2" (63,5mm) X 4 1/2" (114.3mm) X
170mm - FIBRA CARBONO

V1611

R\$ 230,00

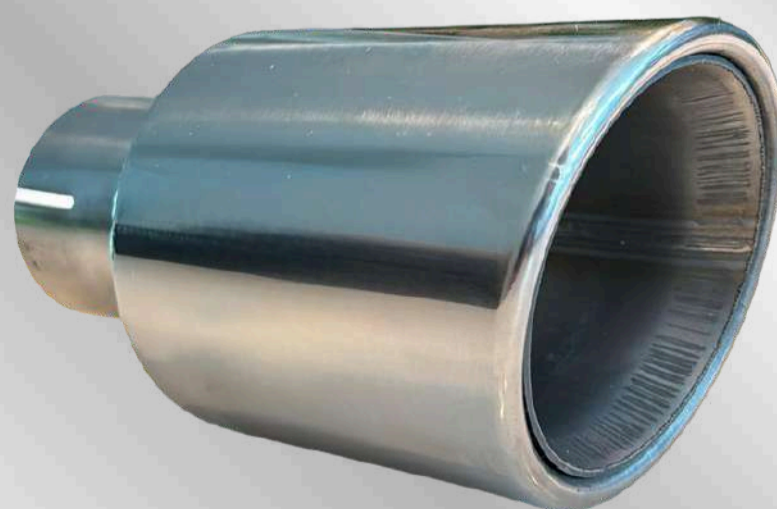

PONT INOX UTILITARIOS REDONDA
2 1/2" (63,5mm) X 4 " (101.6mm) X
185mm - CAPA DUPLA - VIROLADA

V2001

R\$ 713,00



ABAFADOR INOX 2.1/2" X 4" X 570mm
- SILENCIOSO REDONDO 6" (152,4mm)

V2002

R\$ 725,00



ABAFADOR INOX 2.1/2" X 4" X 570mm
- SILENCIOSO OVAL 145mm X 180mm

V2003

R\$ 413,00



ABAFADOR INOX 2.1/2" X 2.1/2" X
390mm SILENCIOSO REDONDO 4"
(101,6mm)

V2004

R\$ 425,00



ABAFADOR INOX 2.1/2" X 2.1/2" X
390mm SILENCIOSO REDONDO 5"
(127,0mm)

V2005

R\$ 788,00



ABAFADOR INOX 2.1/2" X 3.1/2" X
610mm SILENCIOSO OVAL 145,0mm X
180mm PONTEIRA DUPLA

V2006

R\$ 725,00



ABAFADOR INOX 2.1/2" X 5" X 540mm
SILENCIOSO OVAL 145,0mm X
180,0mm

V2007

R\$ 450,00



ABAFADOR INOX 2.1/2" X 3.1/2" X 450mm SILENCIOSO REDONDO 4.1/2" (114,3mm)

V2008

R\$ 463,00



ABAFADOR INOX 2.1/2" X 3.1/2" X 280mm SILENCIOSO REDONDO 5" (127mm) DUPLO RONCO

V2009

R\$ 475,00

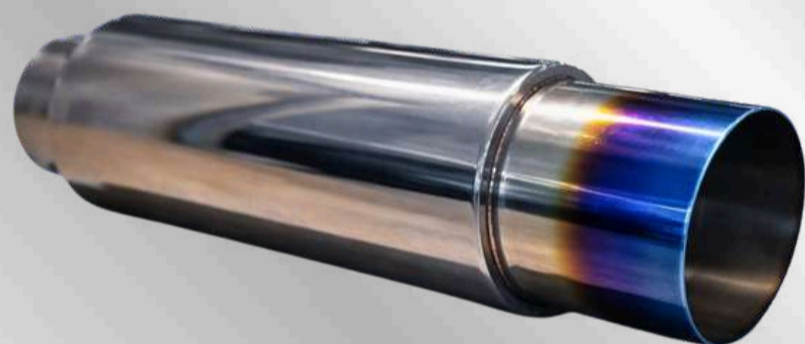

ABAFADOR INOX 2 1/2" X 3 1/2" X 450mm - SILENCIOSO REDONDO 4 1/2" (114,3mm)- AZULADO

V2101

R\$ 25,00



CURVA INOX 90° Ø1" (25,4mm) X
1,20mm

V2102

R\$ 30,00

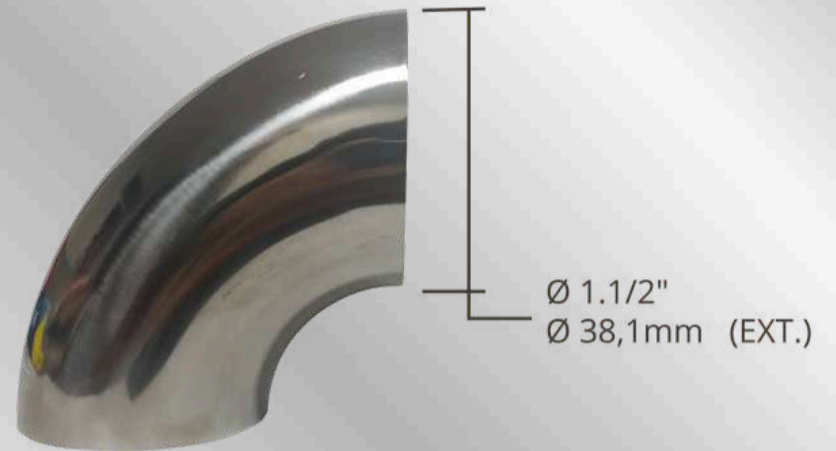

CURVA INOX 90° Ø1.1/2" (38,1mm) X
1,20mm

V2103

R\$ 39,00

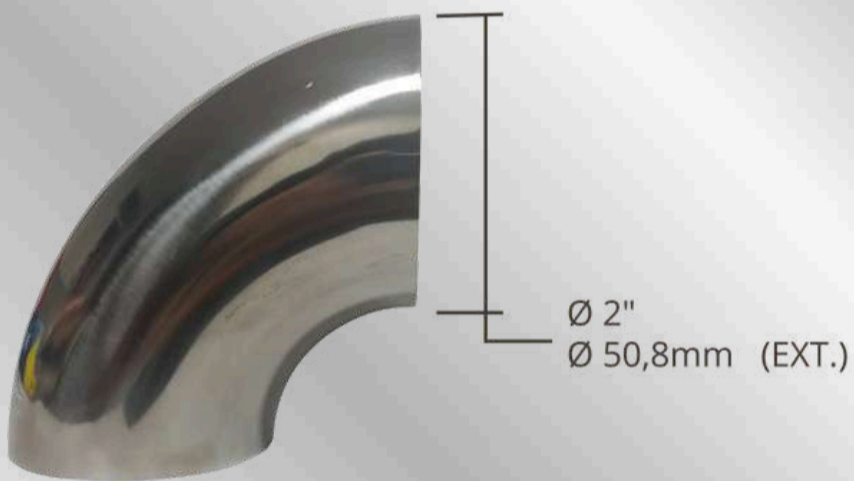

CURVA INOX 90° Ø2" (50,8mm) X
1,20mm

V2104

R\$ 42,00

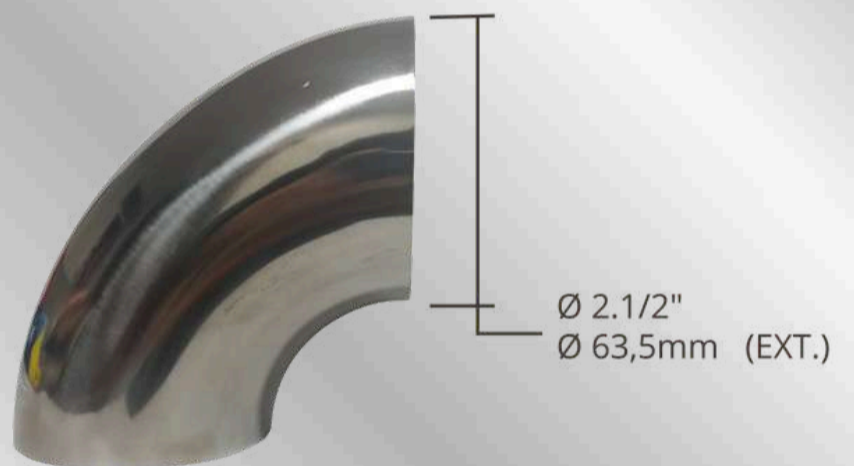

CURVA INOX 90° Ø2.1/2" (63,5mm) X
1,20mm

V2105

R\$ 59,00

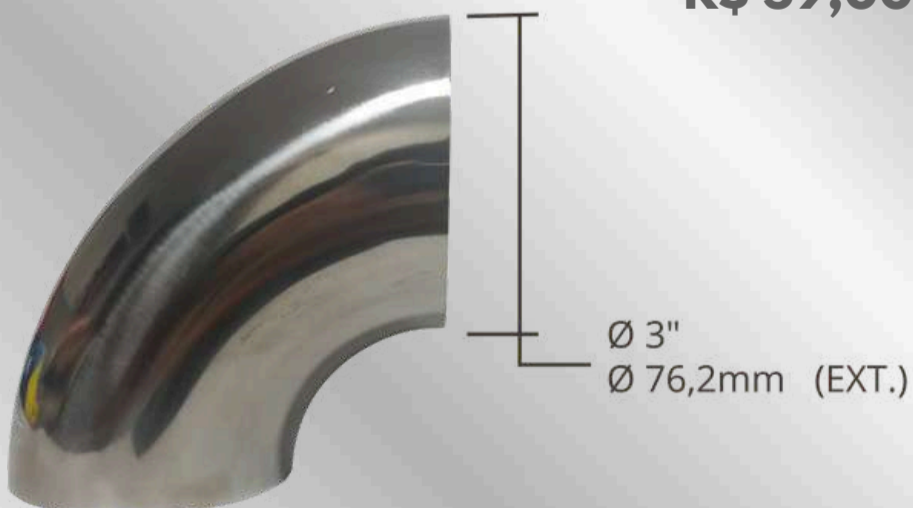

CURVA INOX 90° Ø3" (76,2mm) X
1,20mm

V2106

R\$ 84,00

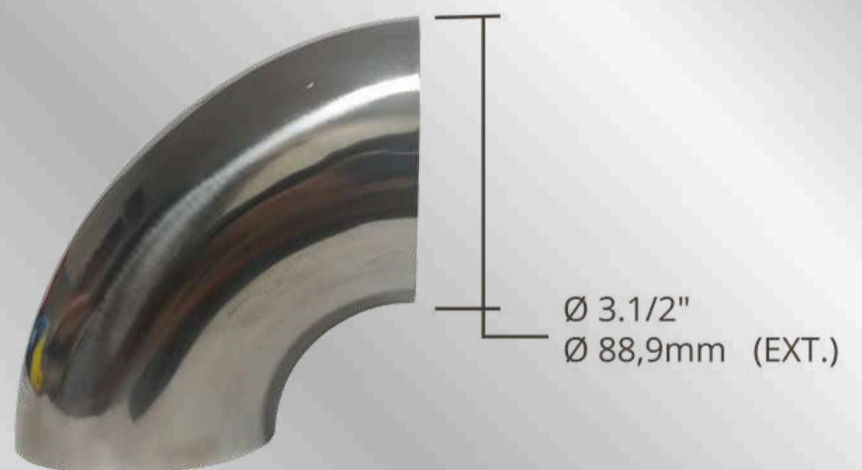

CURVA INOX 90° Ø3.1/2" (88,9mm) X
1,20mm

V2107

R\$ 102,00

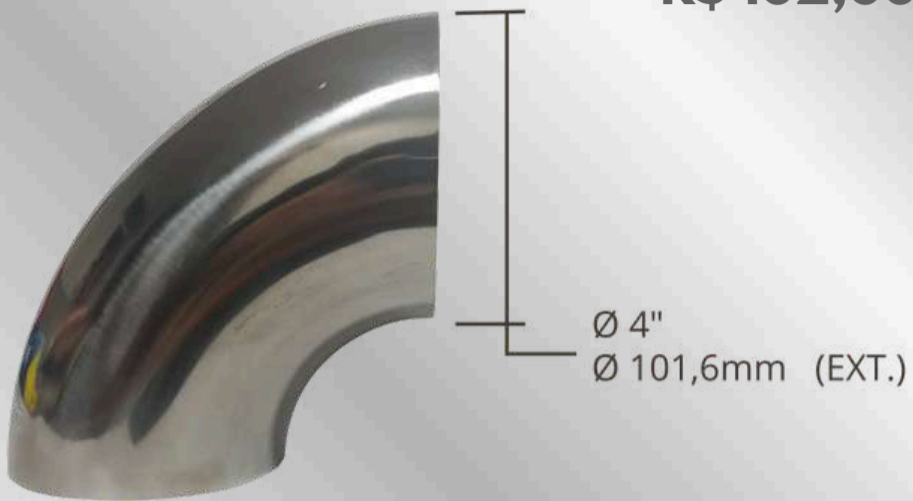

CURVA INOX 90° Ø4" (101,6mm) X
1,20mm

V2108

R\$ 138,00



CURVA INOX 90° Ø4.1/2" (114,3mm) X
1,20mm

V2109

R\$ 79,00

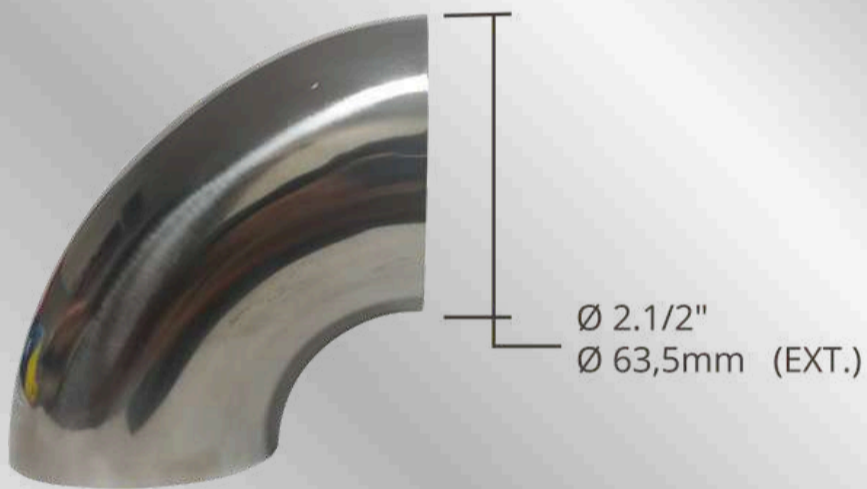

CURVA INOX 90° Ø2.1/2" (63,5mm) X
2,0mm

V2110

R\$ 100,00

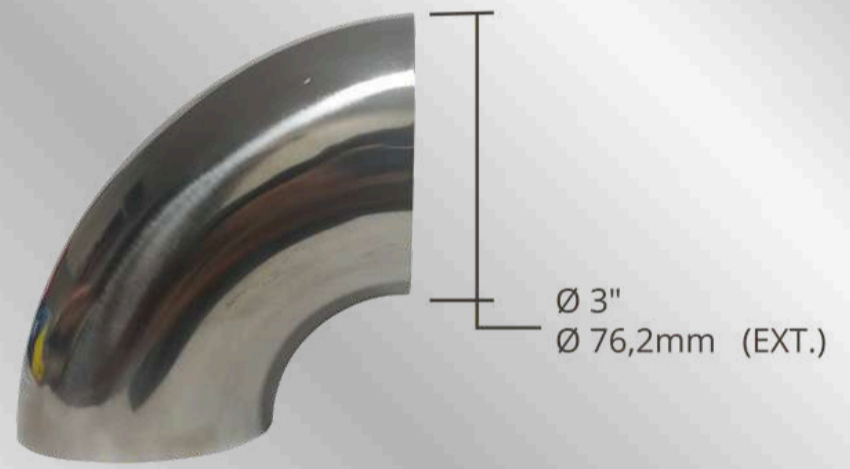

CURVA INOX 90° Ø3" (76,2mm) X
2,0mm

V2115

R\$ 63,00

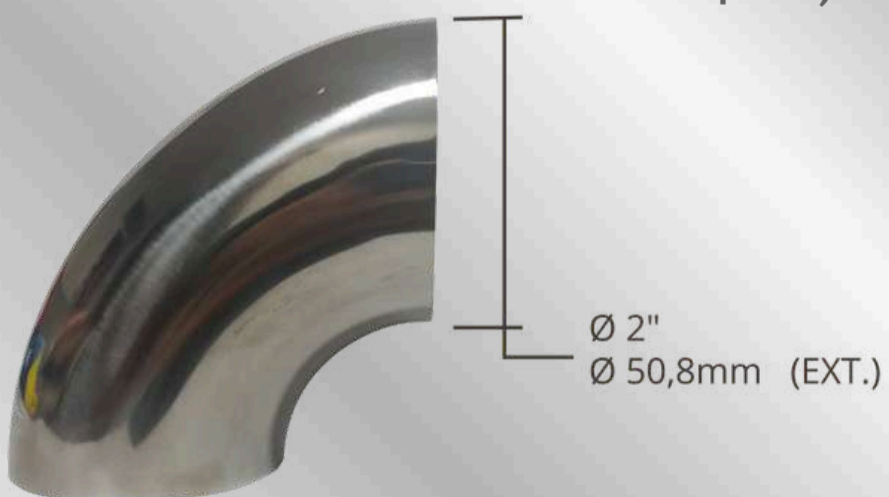

CURVA INOX 90° Ø2" (50,8mm) X
1,50mm

V2116

R\$ 69,00

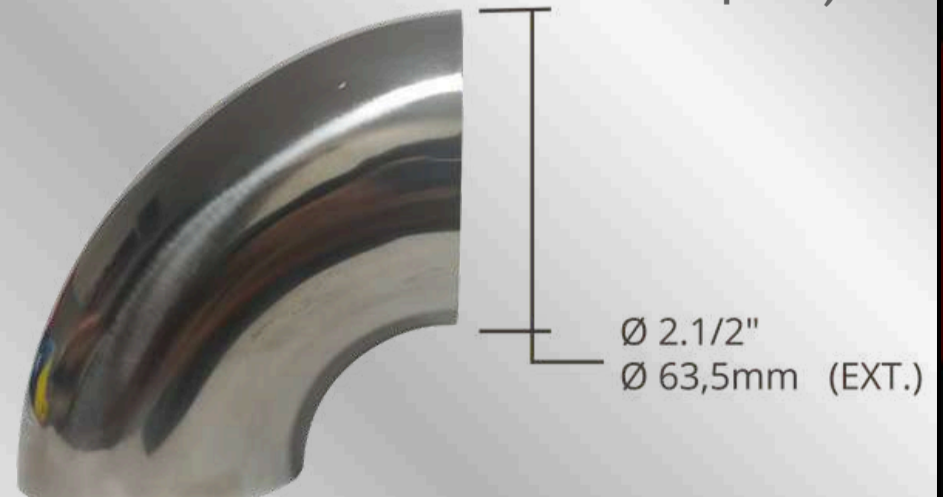

CURVA INOX 90° Ø2.1/2" (63,5mm) X
1,50mm

CURVAS

V2117

R\$ 92,00

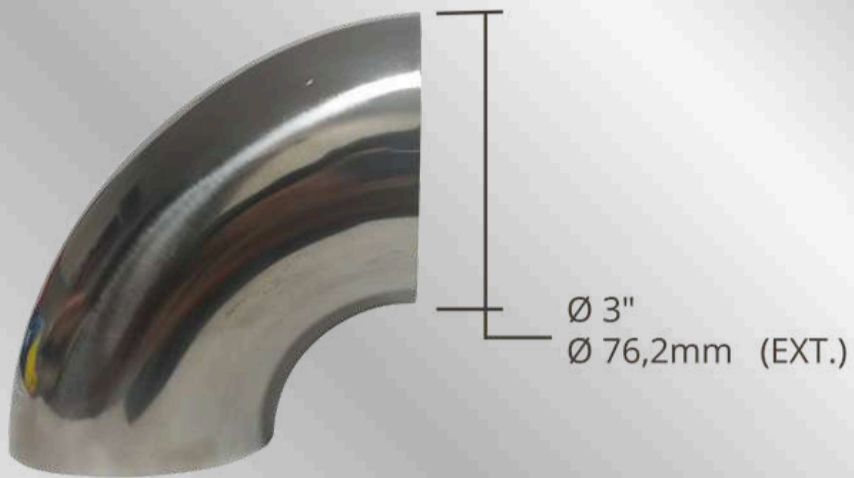

CURVA INOX 90° Ø3" (76,2mm) X
1,50mm

V2118

R\$ 154,00

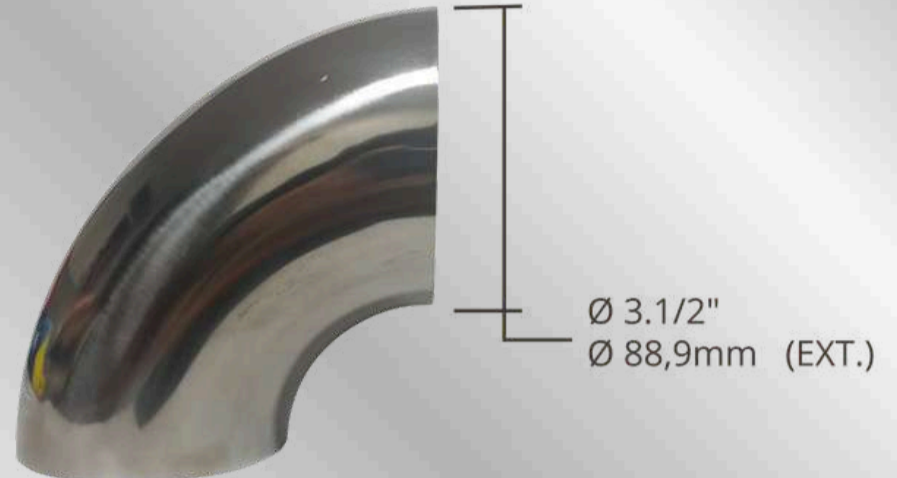

CURVA INOX 90° Ø3.1/2" (88,9mm) X
1,50mm

V2119

R\$ 98,00



CURVA INOX 90° Ø2.1/2" (63,5mm) X
1,50mm - RAI0 LONGO

V2120

R\$ 137,00



CURVA INOX 90° Ø3" (76,2mm) X
1,50mm - RAI0 LONGO

V2121

R\$ 98,00

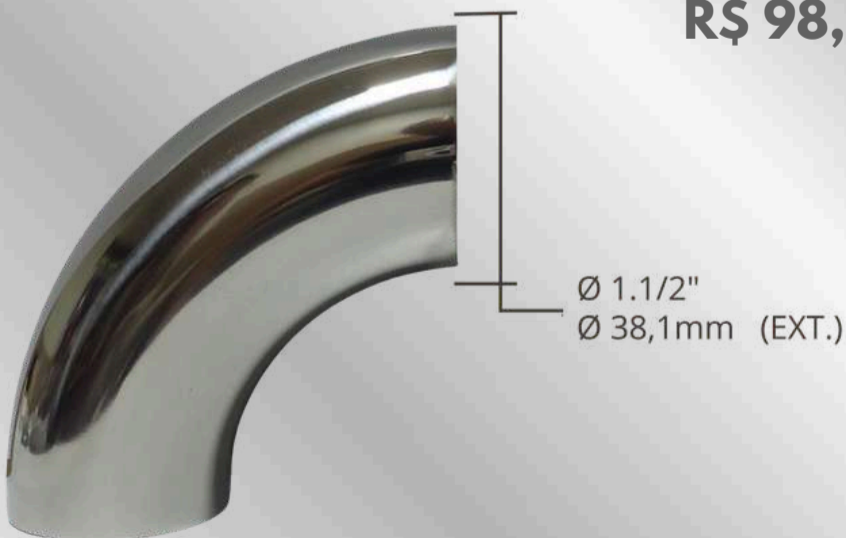

CURVA INOX 90° Ø1.1/2" (38,1mm) X
1,50mm - RAI0 LONGO

V2122

R\$ 137,00



CURVA INOX 90° Ø3" (76,2mm) X
1,50mm - RAI0 LONGO

V2201

R\$ X,00

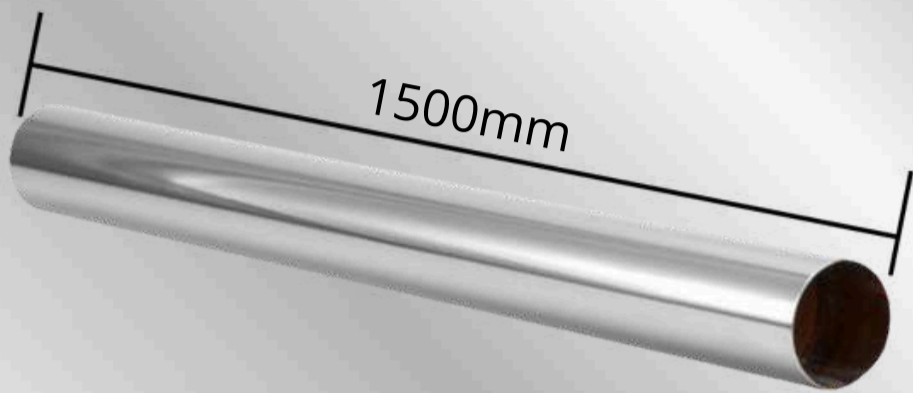

TUBO INOX - Ø EXT. 2" (50,8mm)X
1,5mmX 1500mm PREÇO-SOB
CONSULTA

V2202

R\$ X,00

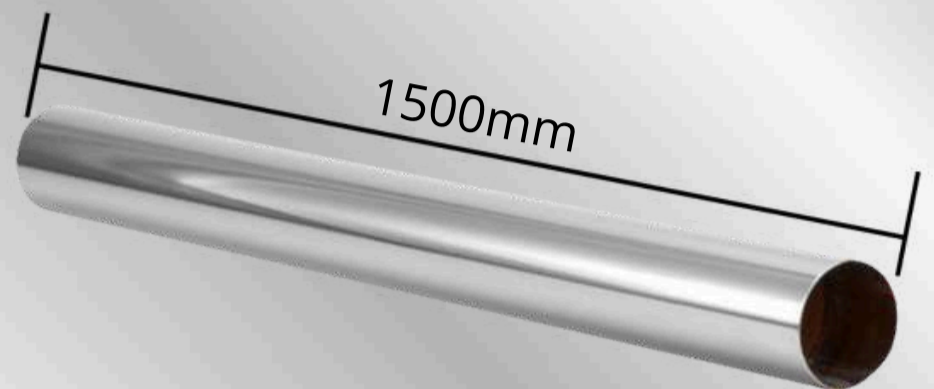

TUBO INOX - Ø EXT. 2.1/2" (63,5mm)X
1,5mmX 1500mm PREÇO-SUB
CONSULTA

V2203

R\$ X,00

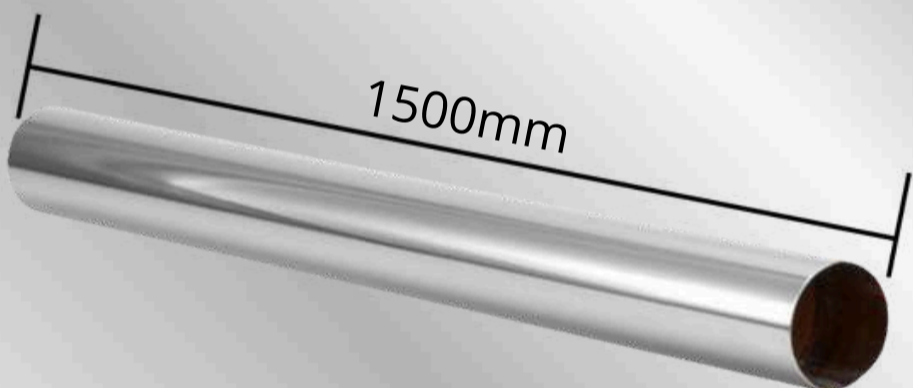

TUBO INOX - Ø EXT. 3" (76,2mm)X
1,5mm X 1500mm PREÇO-SUB
CONSULTA

V2204

R\$ X,00

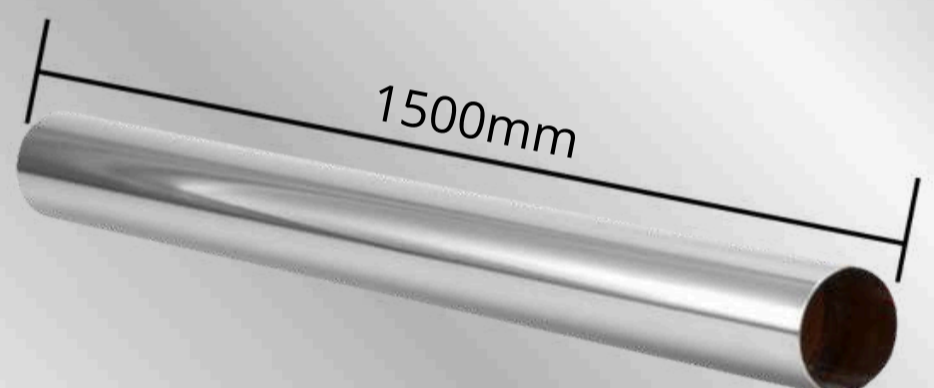

TUBO INOX - Ø EXT. 1.1/2"
(38,10mm)X 1,5mmX 1500mm PREÇO-
SUB CONSULTA

V2301

R\$ 19,00



MANGUEIRA SILICONE 5mm - 4
TRAMAS - RETO - 1/1/2" (38,1mm) X
100mm - AZUL

V2302

R\$ 23,00



MANGUEIRA SILICONE 5mm - 4
TRAMAS - RETO - 2" (50,8mm) X
100mm - AZUL

V2303

R\$ 24,00



MANGUEIRA SILICONE 5mm - 4
TRAMAS - RETO - 2 1/4" (57,15mm) X
100mm - AZUL

V2304

R\$ 26,00



MANGUEIRA SILICONE 5mm - 4
TRAMAS - RETO - 2 1/2" (63,5mm) X
100mm - AZUL

V2305

R\$ 28,00



MANGUEIRA SILICONE 5mm - 4
TRAMAS - RETO - 3" (76,2mm) X
100mm - AZUL

V2306

R\$ 47,00



MANGUEIRA SILICONE 5mm - 4
TRAMAS - 90 GRAUS - 1/1/2" (38,1mm)
X 100mm - AZUL

V2307

R\$ 56,00



MANGUEIRA SILICONE 5mm - 4
TRAMAS - 90 GRAUS - 2" (50,8mm) X
100mm - AZUL

V2308

R\$ 59,00



MANGUEIRA SILICONE 5mm - 4
TRAMAS - 90 GRAUS - 2 1/4"
(57,15mm) X 100mm - AZUL

V2309

R\$ 60,00



MANGUEIRA SILICONE 5mm - 4
TRAMAS - 90 GRAUS - 2 1/2" (63,5mm)
X 100mm - AZUL

V2310

R\$ 69,00



MANGUEIRA SILICONE 5mm - 4
TRAMAS - 90 GRAUS - 3" (76,2mm) X
100mm - AZUL

V2311

R\$ 52,00



MANGUEIRA SILICONE 5mm - 4
TRAMAS - 45 GRAUS - 1 1/2" (38,1mm)
X 100mm - AZUL

V2312

R\$ 60,00



MANGUEIRA SILICONE 5mm - 4
TRAMAS - 45 GRAUS - 2" (50,8mm) X
100mm - AZUL

V2313

R\$ 63,00



MANGUEIRA SILICONE 5mm - 4
TRAMAS - 45 GRAUS - 2 1/4"
(57,15mm) X 100mm - AZUL

V2314

R\$ 65,00



MANGUEIRA SILICONE 5mm - 4
TRAMAS - 45 GRAUS - 2 1/2" (63,5mm)
X 100mm - AZUL

V2315

R\$ 73,00



MANGUEIRA SILICONE 5mm - 4
TRAMAS - 45 GRAUS - 3" (76,2mm) X
100mm - AZUL

V2316

R\$ 117,00

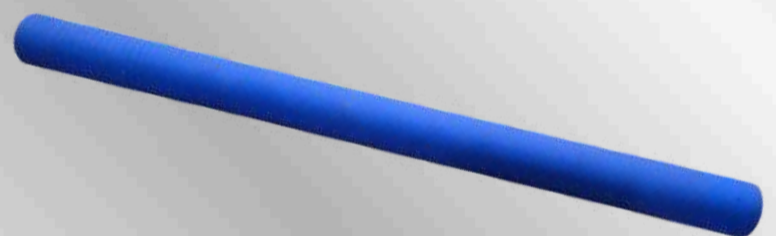

MANGUEIRA SILICONE 5mm - 4
TRAMAS - RETO - 1 1/2" (38,1mm) X
1000mm - AZUL

V2317

R\$ 147,00

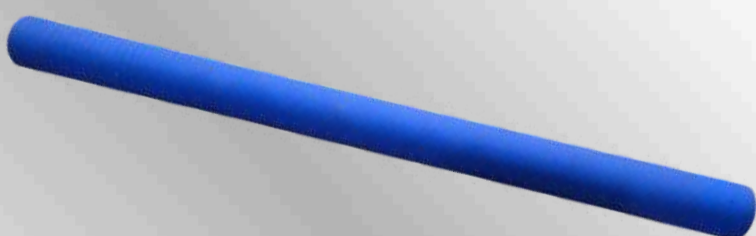

MANGUEIRA SILICONE 5mm - 4
TRAMAS - RETO - 2" (50,8mm) X
1000mm - AZUL

V2318

R\$ 171,00

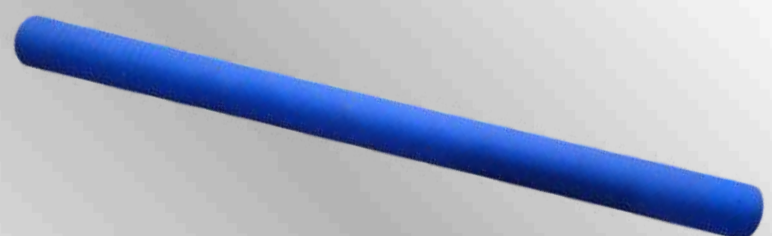

MANGUEIRA SILICONE 5mm - 4
TRAMAS - RETO - 2 1/4" (57,15mm) X
1000mm - AZUL

V2319

R\$ 177,00

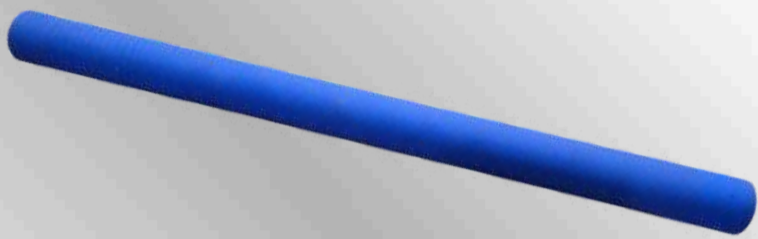

MANGUEIRA SILICONE 5mm - 4
TRAMAS - RETO - 2 1/2" (63,5mm) X
1000mm - AZUL

V2320

R\$ 216,00

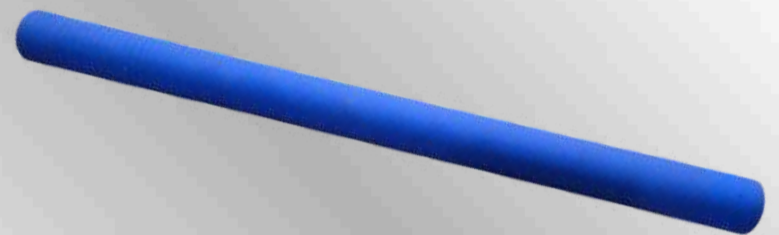

MANGUEIRA SILICONE 5mm - 4
TRAMAS - RETO - 3" (76,2mm) X
1000mm - AZUL

V2321

R\$ 69,00

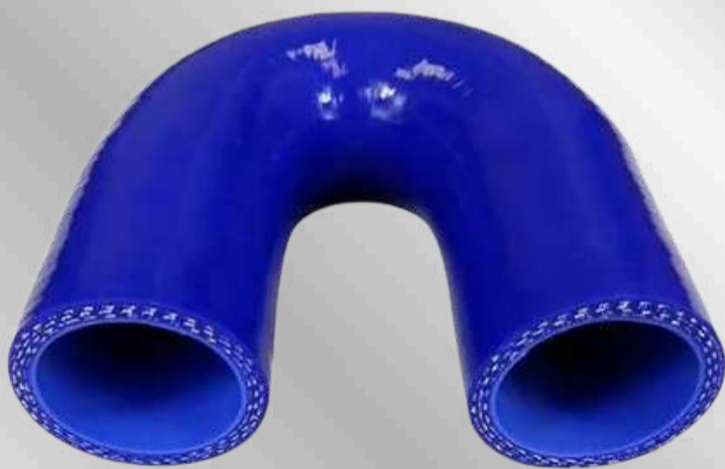

MANGUEIRA SILICONE 5mm - 4
TRAMAS - 180 GRAUS - 1/1/2"
(38,1mm) X 100mm - AZUL

V2322

R\$ 86,00

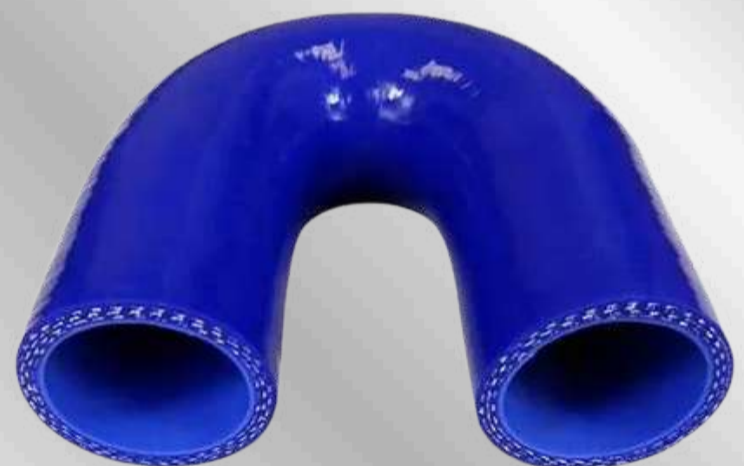

MANGUEIRA SILICONE 5mm - 4
TRAMAS - 180 GRAUS - 2" (50,8mm) X
100mm - AZUL

V2323

R\$ 93,00

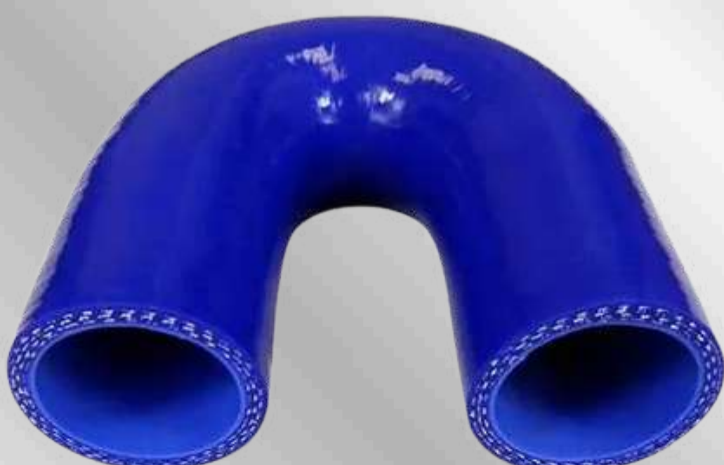

MANGUEIRA SILICONE 5mm - 4
TRAMAS - 180 GRAUS - 2 1/4"
(57,15mm) X 100mm - AZUL 93,00

V2324

R\$ 99,00



MANGUEIRA SILICONE 5mm - 4
TRAMAS - 180 GRAUS - 2 1/2"
(63,5mm) X 100mm - AZUL

V2325

R\$ 112,00

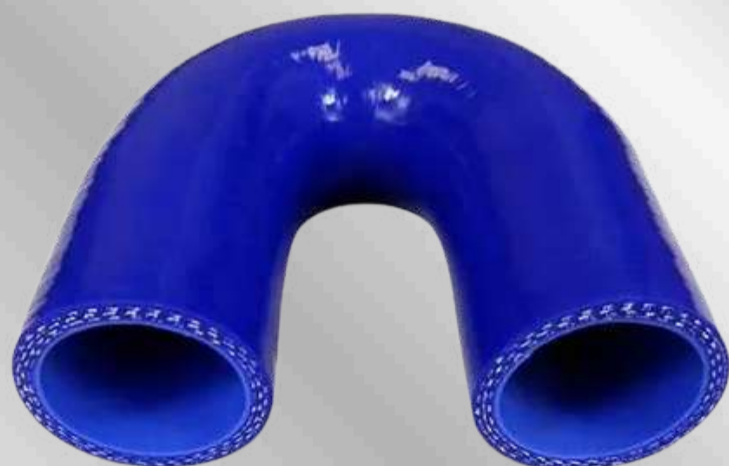

MANGUEIRA SILICONE 5mm - 4
TRAMAS - 180 GRAUS - 3" (76,2mm) X
100mm - AZUL

V2326

R\$ 30,00



MANGUEIRA SILICONE 5mm - 4
TRAMAS - RETO - 3" (76,2mm) X
1000mm - AZUL

V2327

R\$ 28,00



MANGUEIRA SILICONE 5mm - 4
TRAMAS - 180 GRAUS - 1/1/2"
(38,1mm) X 100mm - AZUL

V2501

R\$ 4,00



ABRAÇADEIRA TIPO G - 1.5/8"

V2502

R\$ 4,00



ABRAÇADEIRA TIPO G - 1.3/4"

V2503

R\$ 4,00



ABRAÇADEIRA TIPO G - 1.7/8"

V2504

R\$ 4,00



ABRAÇADEIRA TIPO G - 2"

V2505

R\$ 4,00



ABRAÇADEIRA TIPO G - 2.1/8"

V2506

R\$ 15,00



ABRAÇADEIRA PEUGEOT/RENAULT
59MM 2 PF

V2507

R\$ 4,00



ABRAÇADEIRA VOLKS 1300 A 1600
EXCETO 1200 (C/PF)

V2508

R\$ 6,20



ABRAÇADEIRA TIPO G - 2.1/2"

V2509

R\$ 5,00



ABRAÇADEIRA TIPO G - 1.3/4" -
ZINCADA

V2510

R\$ 5,00



ABRAÇADEIRA TIPO G - 1.7/8" -
ZINCADA

V2511

R\$ 5,00



ABRAÇADEIRA TIPO G - 2" - ZINCADA

V2512

R\$ 5,00



ABRAÇADEIRA TIPO G - 2.1/8" -
ZINCADA

V2513

R\$ 6,30



ABRAÇADEIRA TIPO G - 3"

V2551

R\$ 1,00



ABRACADEIRA TIPO PARAFUSO SEM-FIM 1 1/2" (38,1mm)

V2552

R\$ 1,00



ABRACADEIRA TIPO PARAFUSO SEM-FIM 2" (50,8mm)

V2553

R\$ 1,25



ABRACADEIRA TIPO PARAFUSO SEM-FIM 2 1/2" (63,5mm)

V2554

R\$ 1,25



ABRACADEIRA TIPO PARAFUSO SEM-FIM 3" (76,2mm)

V2561

R\$ 5,25



ABRACADEIRA TIPO TUCHO 19mm x 0,6mm - DIAMETRO (40-46mm)

V2562

R\$ 5,25



ABRACADEIRA TIPO TUCHO 19mm x 0,6mm - DIAMETRO (44-50mm)

V2563

R\$ 5,25



ABRACADEIRA TIPO TUCHO 19mm x
0,6mm - DIAMETRO (48-54mm)

V2564

R\$ 5,50



ABRACADEIRA TIPO TUCHO 19mm x
0,6mm - DIAMETRO (57-65mm)

V2565

R\$ 5,50



ABRACADEIRA TIPO TUCHO 19mm x
0,6mm - DIAMETRO (61-71mm)

V2566

R\$ 5,50



ABRACADEIRA TIPO TUCHO 19mm x
0,6mm - DIAMETRO (69-77mm)

V2567

R\$ 5,50



ABRACADEIRA TIPO TUCHO 19mm x
0,6mm - DIAMETRO (75-83mm)

V2601

R\$ 47,00



BALANCEAMENTO GARRA BAIXA 10g
-100 PEÇAS

V2602

R\$ 62,00



BALANCEAMENTO GARRA BAIXA 15g
-100 PEÇAS

V2603

R\$ 77,00



BALANCEAMENTO GARRA BAIXA 20g
-100 PEÇAS

V2604

R\$ 92,00



BALANCEAMENTO GARRA BAIXA 25g
-100 PEÇAS

V2605

R\$ 108,00



BALANCEAMENTO GARRA BAIXA 30g
-100 PEÇAS

V2606

R\$ 123,00



BALANCEAMENTO GARRA BAIXA 35g
-100 PEÇAS

V2607

R\$ 69,00



BALANCEAMENTO GARRA BAIXA 40g
-50 PEÇAS

V2608

R\$ 79,00



BALANCEAMENTO GARRA BAIXA 45g
-50 PEÇAS

V2609

R\$ 87,00



BALANCEAMENTO GARRA BAIXA 50g
-50 PEÇAS

V2610

R\$ 47,00



BALANCEAMENTO GARRA ALTA 10g
-100 PEÇAS

V2611

R\$ 62,00



BALANCEAMENTO GARRA ALTA 15g
-100 PEÇAS

V2612

R\$ 123,00



BALANCEAMENTO GARRA ALTA 20g
-100 PEÇAS

V2613

R\$ 93,00



BALANCEAMENTO GARRA ALTA 25g
-100 PEÇAS

V2614

R\$ 108,00



BALANCEAMENTO GARRA ALTA 30g
-100 PEÇAS

V2615

R\$ 123,00



BALANCEAMENTO GARRA ALTA 35g
-100 PEÇAS

V2616

R\$ 135,00



BALANCEAMENTO GARRA ALTA 40g
-100 PEÇAS

V2619

R\$ 87,00



BALANCEAMENTO COLANTE 10/5g -
60g - 50 BARRAS

V2620

R\$ 28,00



DISPOSITIVO CORREÇÃO CANGAGEM
- M10

V2621

R\$ 29,00

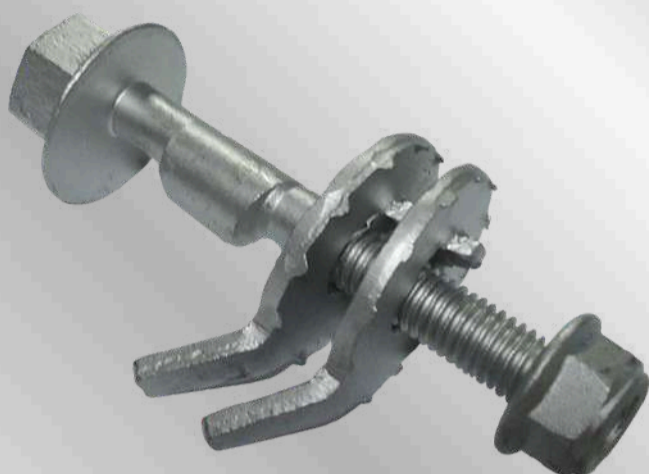

DISPOSITIVO CORREÇÃO CANGAGEM
- M12

V2622

R\$ 41,00



DISPOSITIVO CORREÇÃO CANGAGEM
- M14

V2623

R\$ 44,00



DISPOSITIVO CORREÇÃO CANGAGEM
- M15

V2624

R\$ 47,00

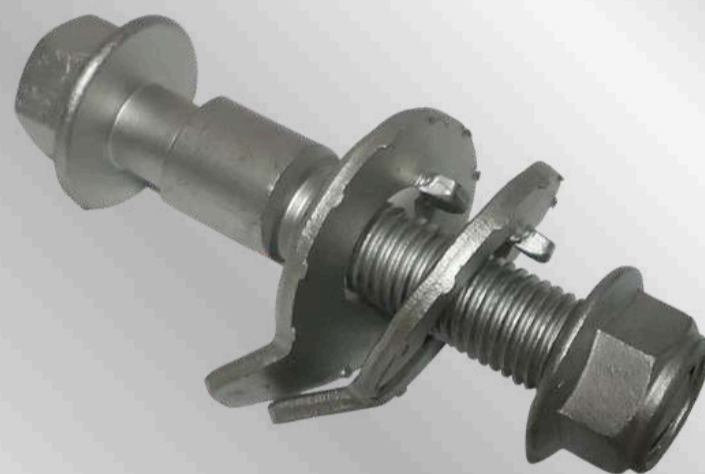

DISPOSITIVO CORREÇÃO CANGAGEM
- M16

V2625

R\$ 75,00



VÁLVULA DE BORRACHA PARA PNEUS
SEM CÂMERA 100 UN

V4501

R\$ 172,00



TUBO MOTOR C/ FLEXÍVEL E SONDA
HYUNDAI HB20 1.0 FLEX - 12...

V4502

R\$ 150,00



TUBO INT. C/ FLEXÍVEL E SONDA FOX/ GOL
1.0 GV 09... FOX/ CROSSFOX/ SPACEFOX/
GOL 1.6 - 10... SAVEIRO 1.6 GV 09...

V4503

R\$ 105,00



TUBO MOTOR C/ FLEXÍVEL UNO MILLE
ECONOMY FIRE FLEX - 09...

V4504

R\$ 150,00



TUBO INT. C/ FLEXÍVEL - PALIO/ PALIO
WEEKEND STRADA/ SIENA/ IDEA/
GRAN SIENA

V4505

R\$ 173,00



TUBO INT. C/ FLEXÍVEL - JEEP
RENEGADE 1.8 E FIAT TORO 1.8

V4506

R\$ 172,00



TUBO MOTOR C/ FLEXÍVEL E SONDA -
HYUNDAI HB20 1.6 16V HATCH/
SEDAN - 15 A 19

V4507

R\$ 172,00



TUBO MOTOR C/ FLEXÍVEL E SONDA -
HYUNDAI HB20S 1.6 16V HATCH 12 A
14/ SEDAN - 13 A 14

V4508

R\$ 174,00



TUBO MOTOR C/ FLEXÍVEL - IX 35 2.0 16V
2WD AUT. - 12

V4509

R\$ 120,00



TUBO INT. C/ FLEXÍVEL UNO MILLE
FIRE FLEX - 06...

V4511

R\$ 184,00



TUBO MOTOR C/ FLEXÍVEL IX35 2.0
16V 2WD AUT. - 12 COM SONDA

V4512

R\$ 192,00



TUBO MOTOR C/ FLEXÍVEL E SONDA
HYUNDAI HB20 1.0 FLEX - 12...
GRAMPEADO

V4513

R\$ 170,00



TUBO INT. C/ FLEXÍVEL E SONDA FOX/
GOL 1.0GV - 09... FOX/ CROSSFOX/
SPACEFOX/ GOL 1.6 - 10... SAVEIRO
1.6 GV 09... - GRAMPEADO

V4514

R\$ 125,00



TUBO INT. C/ FLEXÍVEL UNO MILLE
ECONOMY FIRE FLEX - 09... -
GRAMPEADO

V4515

R\$ 170,00



TUBO INT. C/ FLEXÍVEL PALIO/ PALIO
WEEKEND/ STRADA SIENA/ IDEA/ GRAND
SIENA - GRAMPEADO

V4516

R\$ 193,00



TUBO INT. C/ FLEXÍVEL JEEP
RENEGADE 1.8 E FIAT TORO 1.8 -
GRAMPEADO

V4517

R\$ 192,00



TUBO MOTOR C/ FLEXÍVEL E SONDA
HYUNDAI HB20 1.6 16V HATCH/
SEDAN - 15 A 19 - FLANGE MAIOR -
GRAMPEADO

V4518

R\$ 192,00



TUBO MOTOR C/ FLEXÍVEL E SONDA
HYUNDAI HB20S 1.6 16V HATCH 12 A
14 E SEDAN - 13 A 14 FLANGES IGUAIS
GRAMPEADO

V4519

R\$ 194,00



TUBO MOTOR C/ FLEXÍVEL IX35 2.0
16V 2WD AUT - 12 C

V4520

R\$ 140,00



TUBO INT. C/ FLEXÍVEL UNO MILLE
FIRE FLEX - 06... GRAMPEADO

SILENCIOSOS UNIVERSAL

V4601

R\$ 122,00



SILENCIOSO UNIVERSAL Ø3. 1/2"
(88,9mm) X 330mm ENT. Ø2" (50,8mm)
- SAÍDA Ø2" (50,8mm) - INOX

V4602

R\$ 147,00



SILENCIOSO UNIVERSAL Ø3. 1/2" (88,9mm) X
420mm ENT. Ø2" (50,8mm) - SAÍDA Ø2"
(50,8mm) - INOX

V4603

R\$ 192,00



SILENCIOSO UNIVERSAL Ø3. 1/2"
(88,9mm) X 590mm ENT. Ø2" (50,8mm)
- SAÍDA PONTEIRA POLIDA - INOX

V4701

R\$ 338,00



SIL UNIVERSAL INOX REDONDO 4"
(101,6mm) X 400mm MIOLO INOX 2"
(50,8mm)

V4702

R\$ 463,00



SIL UNIVERSAL INOX REDONDO 5"
(127mm) X 300mm MIOLO INOX 2 1/2"
(63,5mm)

V4703

R\$ 463,00



SIL UNIVERSAL INOX REDONDO 5"
(127mm) X 400mm MIOLO INOX 2 1/2"
(63,5mm)

V4704

R\$ 523,00



SIL UNIVERSAL INOX OVAL (100mm X
150mm) INT. UNO 400mm MIOLO INOX
2 1/2" (63,5mm)

V4705

R\$ 413,00



SIL UNIVERSAL INOX OVAL (100mm X 150mm)
INT. UNO 300mm MIOLO INOX 2 1/2"
(63,5mm)

V4801

R\$ 925,00



CATALISADOR CROSSFOX/GOL/FOX/GOLF/POLO/SAVEIRO/SPACE
FOX/VOYAGE 1.0/1.6 8V 2007 A 2017 COM COLETOR

V4802

R\$ 925,00



CATALISADOR DOBLO/FIORINO/UNO/IDEA/MOBI/PALIO/PALIO
WEEKEND/PUNTO/STRADA 1.0/1.4 EVO 2014...C/COLETOR, RECICLADO E
CARÇAÇA

V4803

R\$ 970,00



CATALISADOR PALIO 1.48V 2009 ... C/ COLETOR RECICLADO E CARÇAÇA

V4804

R\$ 875,00



CATALISADOR HB20/PICANTO 1.0 12V 2012 ... C/ COLETOR RECICLADO E CARÇAÇA

V4805

R\$ 965,00



CATALISADOR LOGAN/SANDEIRO 1.0 3 CIL 12V 2016... C/ COLETOR

V4806

R\$ 925,00



CATALISADOR ONIX/PRISMA/COBALT 1.0/1.4 8V 2012 A 2021 C/ COLETOR E CARÇAÇA

V4807

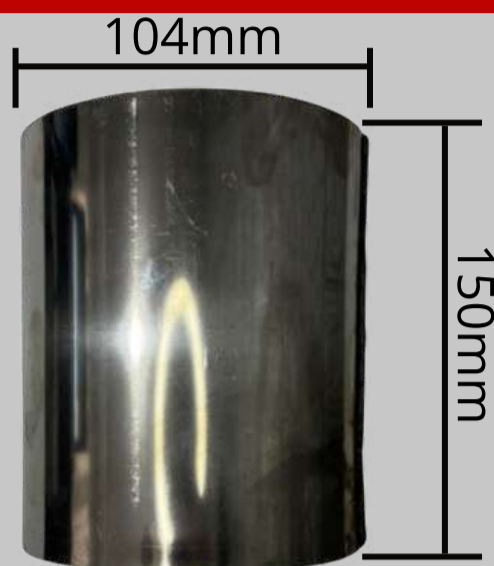

R\$ 460,00
CERAMICA 3,66"



CATALISADOR UNIVERSAL REDONDO 3.66 " ATE 1.2 SEM TAMPA REFIL 150MM

V4808

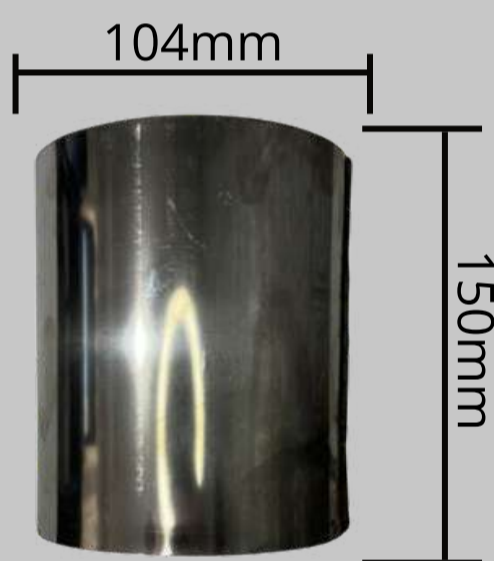

R\$ 590,00
CERAMICA 4,66"



CATALISADOR UNIVERSAL REDONDO 4.66 " ATE 1.6 SEM TAMPA REFIL 150MM

V4809

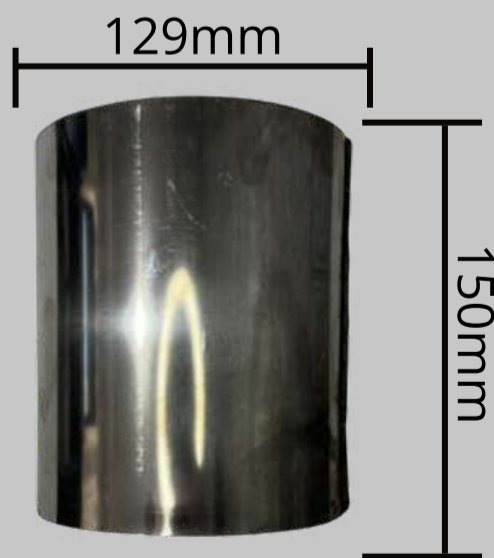

R\$ 685,00
CERAMICA 4,66"

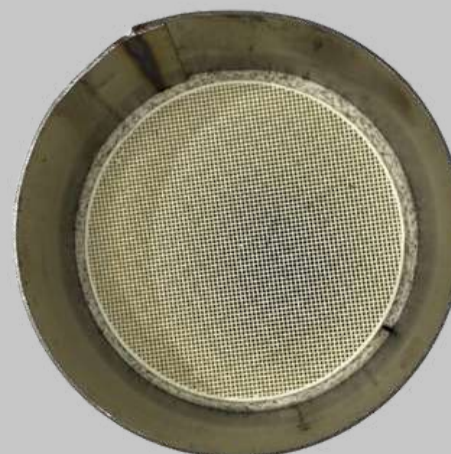

CATALISADOR UNIVERSAL REDONDO 4.66 " ATE 2.2 SEM TAMPA REFIL 150MM

V4810

R\$ 925,00



CATALISADOR AGILE/ CELTA/ CORSA/HATCH/SEDAN/ MERIVA/MONTANA/
ONIX/ PRISMA 1.0/1.4 C/ COLETOR E CARÇAÇA

4850

R\$ 460,00



COLETOR KOMBI 1.4 FLEX C/ PRISIONEIROS (NOVA) - N° orig. 032253031T

4851

R\$ 590,00



COLETOR KOMBI 1.4 FLEXC/ PRISIONEIROS (ANTIGA) - N° orig.032253031T

4854

R\$ 685,00



COLETOR KOMBI / GOLF 1.6 FLEX C/ PRISIONEIROS - N° Orig. 030.253031AP

4856

R\$ 460,00



COLETOR VECTRA / ASTRA / ZAFIRA 2.0/2.2 - 16V C/ PRISIONEIROS - N° Orig. GM90400

4857

R\$ 590,00



COLETOR GOL 1.0 8V AT C/ PRISIONEIROS - N° Orig. 030253031N

4858

R\$ 685,00



COLETOR DO ESCAPAMENTO PALIO UNO 1.0 8V FIRE 2001 - N° Orig. 55190001

4862

R\$ 460,00



**COLETOR ESCAPE GOL / PARATI / SAVEIRO / SANTANA 1.6/1.8 AP C/
PRISIONEIROS - N°**

V4901

R\$ 225,00



PORCA SEXTAVADA 5/16" - CHAVE 14
VENDAS MÚLTIPLOS PACOTE 5
MILHEIROS

V4902

R\$ 40,00



EXTENSOR / PROLONGADOR UNIVERSAL P/
SONDA LAMBDA SEXTAVADO

V4903

R\$ 40,00



EXTENSOR / PROLONGADOR
UNIVERSAL P/ SONDA LAMBDA
REDONDO

V4904

R\$ 22,00



SONDA LAMBDA INOX M18 X 1,5 -
15mm

V4905

R\$ 15,00



SONDA LAMBDA AÇO M18 X 1,5 -
15mm

V4906

R\$ 15,00



SONDA LAMBDA AÇO M18 X 1,5 -
15mm - SEXTAVADO

V4914

R\$ 263,00



ALICATE C/ CORRENTE PARA CORTAR
TUBO DE AÇO

V4915

R\$ 163,00



CORRENTE PARA ALICATE CORTE TUBO

V4916

R\$ 13,00



FLANGE ESTAMPADA GOL Ø INT.
1.3/4" (44,45mm)

V4917

R\$ 13,00



FLANGE ESTAMPADA GOL Ø INT.
1.7/8" (47,6mm)

V4918

R\$ 19,00



FLANGE ESTAMPADA UNO/ FIORINO Ø
INT. 1.3/4" (44,45mm)

V4919

R\$ 23,00



FLANGE 8mm VECTRA/ ASTRA/
ZAFIRA/ MERIVA Ø INT. 1.3/4"
(44,45mm)

V4920

R\$ 30,00



FLANGE 8mm ESCAREADA Ø INT.
1.3/4" (44,45mm)

V4921

R\$ 30,00



FLANGE 8mm ESCAREADA Ø INT. 2" (50,8mm)

V4922

R\$ 23,00



FLANGE 6,35mm Ø INT. 1.3/4"
(44,45mm)

V4923

R\$ 23,00



FLANGE 6,35mm Ø INT. 2" (50,8mm)

V4924

R\$ 27,00



FLANGE ESCAREADA 8mm Ø INT.
1.3/4" (44,45mm)

V4925

R\$ 38,00



FLANGE ESTAMPADA VECTRA/ ASTRA
Ø INT. 1.3/4" (44,45mm) ROSCA M8
PASSO 1

V4926

R\$ 38,00



FLANGE ESTAMPADA VECTRA/ ASTRA
Ø INT. 2" (50,8mm) ROSCA M8 PASSO 1

V4927

R\$ 38,00



FLANGE ESTAMPADA CIVIC/ CITY Ø INT.
1.3/4" (44,45mm)

V4928

R\$ 8,00



SUORTE ESTAMPADO GOL BOLA

V4912

R\$ 4,00



GANCHO PARA ORGANIZAR ESTOQUE
ESCAPAMENTOS

V6801

R\$ 75,00



COPO TÉRMICO A VÁCUO DE AÇO
INOX - CORES DIVERSAS

VBAND

V4907

R\$ 35,00

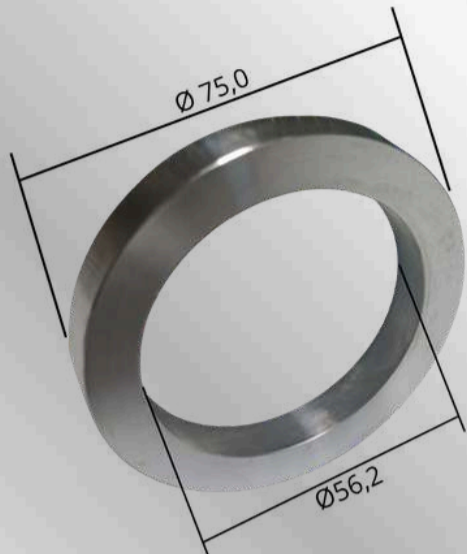

FLANGE INOX V-BAND 2''(50.8mm) X
3''(76.2mm)

V4908

R\$ 40,00

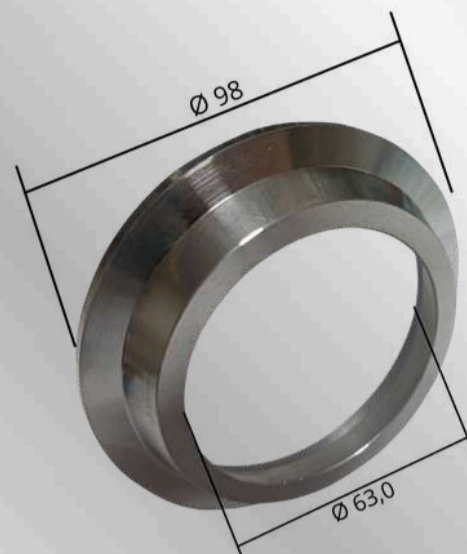

FLANGE INOX V-BAND 2 1/2''(63.5mm) X
3 1/2''(88.9mm)

V4909

R\$ 45,00

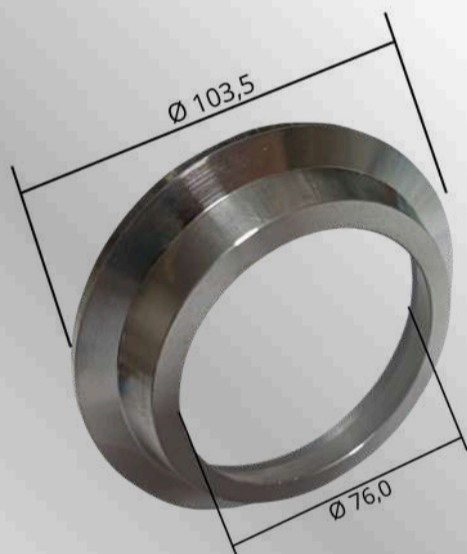

FLANGE INOX V-BAND 3''(76.2mm) X
4''(101.6mm)

V4929

R\$ 44,00



ABRAÇADEIRA V-BAND 2''

V4930

R\$ 52,00



ABRAÇADEIRA V-BAND 2.1/2''

V4931

R\$ 59,00



ABRAÇADEIRA V-BAND 3''

V4933

R\$ 120,00



KIT ABRAÇADEIRA V-BAND 2" - C/
FLANGE

V4934

R\$ 150,00



KIT ABRAÇADEIRA V-BAND 2 1/2" - C/
FLANGE

V4935

R\$ 180,00



KIT ABRAÇADEIRA V-BAND 3" - C/
FLANGE

DIFUSORES

V6501

R\$ 900,00



DIFUSOR INOX 2" (50,8mm) - C/
CONTROLE

V6502

R\$ 900,00



DIFUSOR INOX 2.1/2" (63,5mm) - C/
CONTROLE

V6503

R\$ 900,00



DIFUSOR INOX 3" (76,2mm) - C/
CONTROLE

V6507

R\$ 245,00



MOTOR DIFUSOR

V6508

R\$ 225,00



CENTRAL COM CONTROLE DIFUSOR

APITOS

V6515

R\$ 23,00



APITO ESPORTIVO PARA
ESCAPAMENTO AUTOMOTIVO - LIGA
DE ALUMÍNIO - DIÂMETRO 32-43 MM -
TAMANHO S

V6516

R\$ 26,00



APITO ESPORTIVO PARA ESCAPAMENTO
AUTOMOTIVO - LIGA DE ALUMÍNIO -
DIÂMETRO 37-48 MM - TAMANHO M

V6517

R\$ 30,00



APITO ESPORTIVO PARA
ESCAPAMENTO AUTOMOTIVO - LIGA
DE ALUMÍNIO - DIÂMETRO 44-55 MM -
TAMANHO L

V6518

R\$ 35,00



APITO ESPORTIVO PARA
ESCAPAMENTO AUTOMOTIVO - LIGA
DE ALUMÍNIO - DIÂMETRO 56-85 MM -
TAMANHO XL

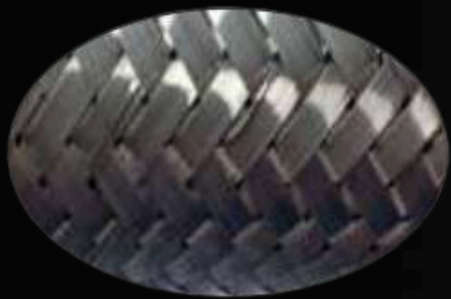

MALHA

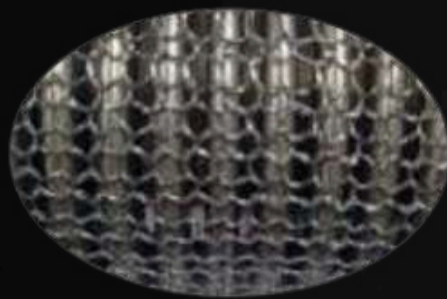

TELA



**PARCEIRA
da NATUREZA**



PRESERVE O MEIO AMBIENTE USE CONTRAPESOS METÁLICOS VIPPARTS

VIP Parts



+30 ANOS DE CREDIBILIDADE



www.vipparts.com.br

vendas@vipparts.com.br

Fone/ WhatsApp (47) 2122-4363

Rua Henrique Coppi - N°478 - Sala 5

Centro - 88340-290 Camboriu - SC